

BackBeatFIT 6100



User Guide

Contents

Headphone overview	3
Install the app	4
Fit	5
Pair	6
First time pair	6
Pair second device	6
Basics	7
Charge your Headset	7
Answer or end a call	7
Volume	7
Mute	7
Play or pause music	7
Track forward	8
Track backward	8
Use VPA (virtual personal assistant)	8
OpenMic	8
Support	10

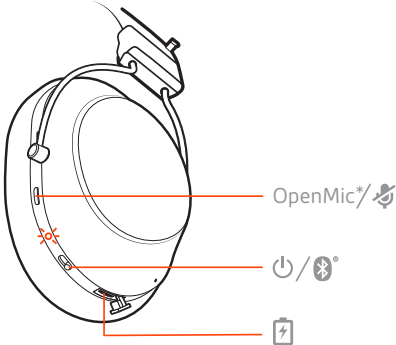
Headphone overview



-  Mute
-  Charge port
-  Headset LED
-  Power button

**OpenMic lets you hear surrounding sound without taking off your headphones. See "OpenMic".*

Install the app

Get the most from your headset by downloading our free app, BackBeat for iOS/Android™.

With this app, you can:

- Select language
- Turn features on/off
- Find MyHeadset
- View the user guide

For maximum benefit, install the BackBeat app on every device paired to the headset.



Fit

The BackBeat FIT 6100 has an adjustable headband system.

Unhook the cord on the headband from the top resting position and tighten by pulling and securing the cord in the down position.

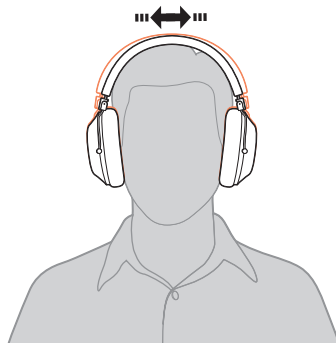
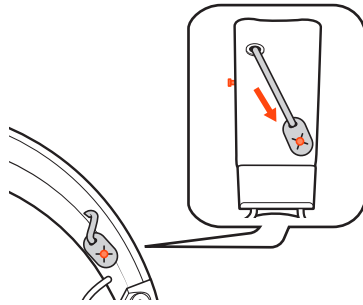

Pair

- First time pair** 1 Slide the power switch on. You hear "pairing" and the LEDs flash red and white.



- 2 Activate **Bluetooth®** on your phone and set it to search for new devices.
 - **iPhone Settings > Bluetooth > On***
 - **Android Settings > Bluetooth: On > Scan for devices***

NOTE *Menus may vary by device.
- 3 Select "PLT BBFIT6100."
If necessary, enter four zeros (0000) for the passcode or accept the connection.
Once successfully paired, you hear "pairing successful" and the LEDs stop flashing.

- Pair second device** 1 Slide and hold the power button towards the Bluetooth icon until the LEDs flash red and white.



- 2 Activate **Bluetooth®** on your device and set it to search for new devices.
 - **iPhone Settings > Bluetooth > On***
 - **Android Settings > Bluetooth: On > Scan for devices***

NOTE *Menus may vary by device.
- 3 Select "PLT BBFIT6100."
If necessary, enter four zeros (0000) for the passcode or accept the connection.
Once successfully paired, you hear "pairing successful" and the LEDs stop flashing.

Basics

Charge your Headset

Use a micro USB cable to charge your headset; while charging the LED will show solid white. A full charge takes up to 2.5 hours, the LED will turn off when charge is complete. A full charge delivers 24 hours of listen and talk time at 50% volume.

Answer or end a call

Tap the Call button located in the center of the right earcup to answer or end a call.

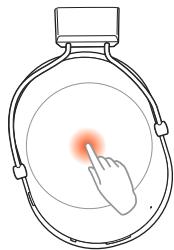

Volume

Swipe up or down on the outside of the right earcup to increase or decrease volume.

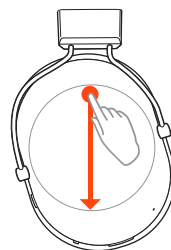
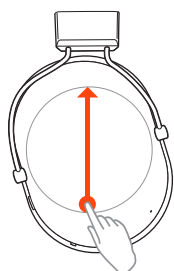

Mute

To mute the audio, while on a call, press the mute button on the side of the right earcup.

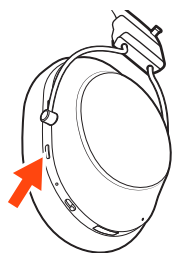

Play or pause music

Tap the center of the right earcup to pause or play audio.

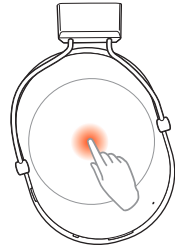

Track forward

Swipe forward on the outside of the right earcup to track audio forward.

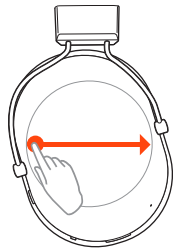

Track backward

Swipe backwards on the outside of the right earcup to track audio backward.

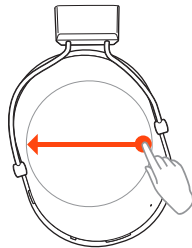

Use VPA (virtual personal assistant)

To activate the virtual personal assistant press and hold the center of the right earcup for 2 seconds.

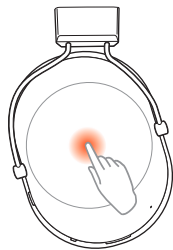

OpenMic

While not on a call, tap the Mute button to hear your surroundings. Swipe the outside of the right earcup to adjust the amount of surrounding sound you hear.

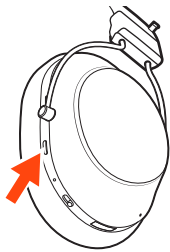

Support

NEED MORE HELP?

plantronics.com/support

Plantronics, Inc.

345 Encinal Street
Santa Cruz, CA 95060
United States

Plantronics B.V.

Scorpius 171
2132 LR Hoofddorp
Netherlands

© 2019 Plantronics, Inc. Bluetooth is a registered trademark of Bluetooth SIG, Inc. and any use by Plantronics, Inc. is under license. All other trademarks are the property of their respective owners.

215185-06 06.19 Model BF6100S