

# BackBeat SENSE

User Guide

# Contents

Overview	3
Headset overview	3
What's in the box	4
Pair	5
Get Paired	5
Pair second device	5
Pair to Mac	5
Charge and fit	6
Charge	6
Adjust the fit	6
The basics	7
Play/pause music	7
Volume	7
Track selection	7
Activate voice assistant	7
Open mic	7
Make/Take/End Calls	7
Mute	7
Flexible power	7
More Features	8
Use sensors	8
Enable HD voice	8
Customize	8
Support	9

# Overview

## Headset overview

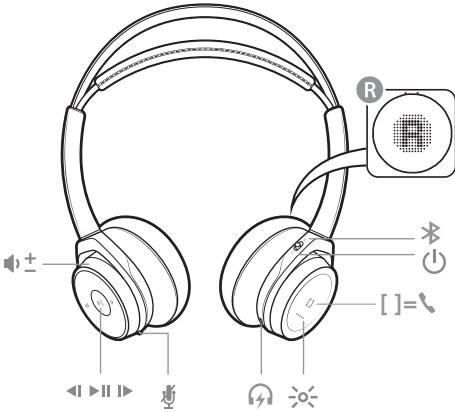

	Volume up/down
	Track forward
	Play/pause music
	Track backward
	Mute/unmute; Open mic
	Charge port
	Headset LEDs
	Call button
	Power switch
	Bluetooth pair button

# What's in the box



Headphones

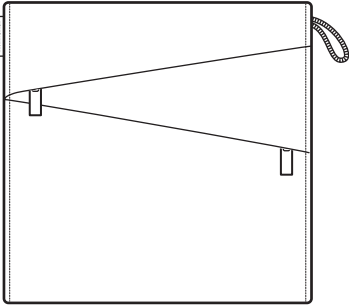

Carrying case

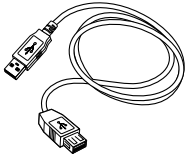

Charging cable



3.5mm Apple cable

# Pair

**Get Paired** The first time you power on your headphones, the pairing process begins.

- 1 Slide the power switch on. You hear "pairing" and the LEDs flash red and blue.

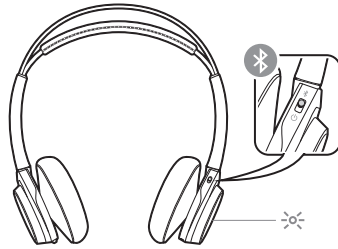

- 2 Activate **Bluetooth®** on your phone and set it to search for new devices.

- **iPhone Settings > Bluetooth > On\***
- **Android Settings > Bluetooth: On > Scan for devices\***

**NOTE** \*Menus may vary by device.

- 3 Select "PLT\_BBTSENSE."

If necessary, enter four zeros (0000) for the passcode or accept the connection.

Once successfully paired, you hear "pairing successful" and the LEDs stop flashing.

**Pair second device** 1 Slide and hold the power button towards the Bluetooth icon until the LEDs flash red and blue.

- 2 Activate Bluetooth on your second device and follow steps 2 and step 3 in "Get Paired."



**Pair to Mac** If your Mac is Bluetooth enabled, you can pair your headset to it.

- 1 Place your headset in pair mode (slide and hold the power button towards the Bluetooth icon). You will hear "pairing" and the LEDs will flash red and blue.
- 2 On your Mac, choose **Apple menu > System Preferences > Bluetooth**.
- 3 Click **Set Up New Device** or "+", select "PLT\_BBTSENSE Stereo" and follow the onscreen instructions.

# Charge and fit

## Charge

It takes up to 2.5 hours to fully charge your headphones. The LEDs turn off once charging is complete.

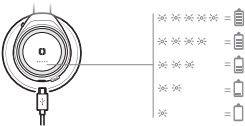

**TIP** To check the headphones battery status, tap the Call button [ ] while wearing your headphones. Headphones must be in idle state.

Your headphones have up to 18 hours of listening time.

## Adjust the fit

Adjust the headphones for a comfortable fit.

Lengthen or shorten the band until it fits comfortably.

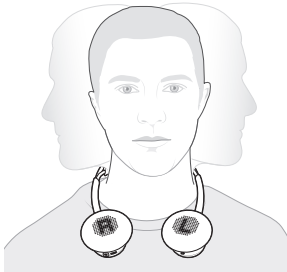

# The basics

Play/pause music	Tap the Play/pause ►    button.
Volume	Toggle the Volume 🔊 wheel forward (+) or backward (–) to control the volume. <b>NOTE</b> <i>Set Android phone volume to medium/high for optimum sound quality.</i>
Track selection	Tap the Forward ◀   button or Back   ▶ button to control the track selection.
Activate voice assistant	If your smartphone has a voice-enabled assistant, press and hold the Call [ ] button for 2 seconds and wait for the phone prompt.
Open mic	Tap the red 🎧 button to hear your natural surroundings (your music/audio will pause).
Make/Take/End Calls	<p>You will hear an incoming call alert while listening to audio. When you take the call, your stored audio (downloaded tunes, video or podcasts) will pause. If you are listening to live streaming audio then it will mute, not pause, during your call. Once you end your call, your playback or streaming will resume.</p> <p><b>Answer a call</b> Choose:</p> <ul style="list-style-type: none"><li>• Put on the headset to answer call, or</li><li>• Tap the Call button [ ]</li></ul> <p><b>End a call</b> Tap the Call button [ ] to end current call.</p> <p><b>Decline a call</b> Press and hold the Call [ ] button for 2 seconds.</p> <p><b>Call back last call (smartphone)</b> To dial your last number you dialed, double-tap the Call [ ] button.</p>
Mute	During a call, press the red 🎧 button. You hear "mute on/off." While muted, taking off the headphones transfers the call to your phone.
Flexible power	<p>When the battery is exhausted use your headphones with the provided 3.5 mm Apple cable.</p> <p><b>Use the cable to:</b></p> <ul style="list-style-type: none"><li>• Adjust the volume with the (+) and (–) buttons*</li><li>• Play/pause music or answer/end a call with the ◯ button = single tap</li><li>• Track forward with the ◯ button = double tap*</li><li>• Track backward with the ◯ button = triple tap*</li><li>• Activate smartphone voice-enabled assistant with the ◯ button = 3 second press</li></ul> <p><b>NOTE</b> <i>*Function may vary by type of phone.</i></p>

# More Features



Use sensors      Smart sensors respond when you put on or take off your headphones.

**Putting on your headphones will:**

- Resume music
- Answer a call

**Taking off your headphones will:**

- Pause music (while music is playing)
- Transfer active call to phone
- Set timer for DeepSleep



**TIP** To disable the sensors, hold both the Mute  and Call  buttons for more than 6 seconds until the LED flashes purple then red. Repeat to reactivate; the LED flashes purple then blue.

**Reset Sensors**

You may need to reset the sensors if they are not working as expected.

To reset the headset sensors, connect it directly to your computer's USB port, and place it, with the ear cups up, on a flat, non-metallic surface for more than 10 seconds.

**Disable sensors**

To disable the sensors, hold both the Mute  and Call  buttons for more than 6 seconds until the LED flashes purple then red. Repeat to reactivate; the LED flashes purple then blue.

Enable HD voice      To enable HD voice (wideband), hold both the red button and Play/pause  buttons for more than 6 seconds until the LEDs flash purple then blue. Repeat to disable; the LEDs flash purple then red.  
**NOTE** HD voice functions properly when both devices support it.

Customize      You can change the language and other settings by downloading Plantronics Hub for Windows and Mac at [plantronics.com/software](http://plantronics.com/software). You can also download the free mobile apps Plantronics Hub for iOS and Android.

Plantronics Hub enables you to:

- Change language (Plantronics Hub for Windows and Mac only)
- Receive firmware updates (Plantronics Hub for Windows and Mac only)
- Turn "mute off" voice alert on/off
- Turn smart sensors on/off



# Support

---

<b>EN</b> Tel: 0800 410014	<b>FI</b> Tel: 0800 117095	<b>NO</b> Tel: 80011336
<b>AR</b> Tel: +44 (0)1793 842443*	<b>FR</b> Tel: 0800 945770	<b>PL</b> Tel: +44 (0)1793 842443*
<b>CS</b> Tel: +44 (0)1793 842443*	<b>GA</b> Tel: 1800 551 896	<b>PT</b> Tel: 0800 84 45 17
<b>DA</b> Tel: 80 88 46 10	<b>HE</b> Tel: +44 (0)1793 842443*	<b>RO</b> Tel: +44 (0)1793 842443*
<b>DE</b> Deutschland 0800 9323 400 Österreich 0800 242 500 Schweiz 0800 932 340	<b>HU</b> Tel: +44 (0)1793 842443*	<b>RU</b> Tel: 8-800-100-64-14 Tel: +44 (0)1793 842443*
<b>EL</b> Tel: +44 (0)1793 842443*	<b>IT</b> Tel: 800 950934	<b>SV</b> Tel: 0200 21 46 81
<b>ES</b> Tel: 900 803 666	<b>NL</b> NL 0800 7526876 BE 0800 39202 LUX 800 24870	<b>TR</b> Tel: +44 (0)1793 842443*

---

*\*Support in English*

For warranty details, go to [plantronics.com/warranty](http://plantronics.com/warranty).

## NEED MORE HELP?

[plantronics.com/support](http://plantronics.com/support)

**plantronics®**

Simply Smarter Communications™

### **Plantronics, Inc.**

345 Encinal Street  
Santa Cruz, CA 95060  
United States

### **Plantronics BV**

South Point Building C  
Scorpius 140  
2132 LR Hoofddorp, Netherlands

© 2015 Plantronics, Inc. All Rights Reserved. Bluetooth is a registered trademark of Bluetooth SIG, Inc. and any use by Plantronics is under license. All other trademarks are the property of their respective owners.

Patents pending.

205086-06 (09.15)