

CORDLESS HEADSET TELEPHONE CT11/12

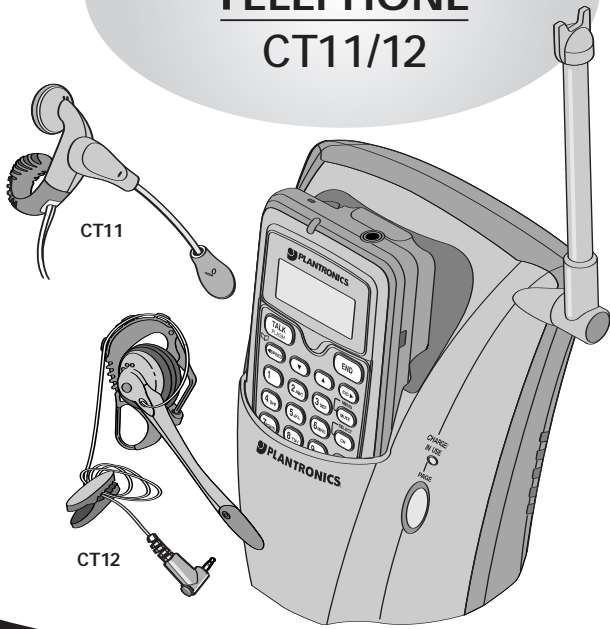

QUICK START USER GUIDE

WELCOME

Thank you for selecting the Cordless Headset Telephone from Plantronics. You have made the right choice for comfort and versatility.

This is a 2.4 GHz DSS cordless telephone system with Caller ID. It offers hands-free convenience and long-range workspace mobility.

This side of the guide has the Important Safety Instructions, please read them first before setting up your system. The other side of this guide will identify the supplied components and has five steps to get you quickly set up and using your system.

The Product Information Booklet, which includes Phonebook operation, Caller ID and other technical features, details of the customizing features and troubleshooting is available at our website.

www.plantronics.com/documentation/

Choose your preferred language and your model to get complete access to user guide documentation.

IMPORTANT SAFETY INSTRUCTION

⚠ When using your telephone equipment, these basic safety precautions should be followed to reduce the risk of fire, electric shock, and injury to persons.

1. Read and understand all instructions.
2. Follow all warnings and instructions marked on the product. The symbol ⚠ identifies and alerts the user to the presence of important operating and service instructions.
3. Unplug this product from the wall outlet before cleaning. Do not use liquid cleaners or aerosol cleaners. Use a damp cloth for cleaning.
4. Do not locate this product near water, for example, near a bathtub, kitchen sink, or laundry tub, in a wet basement or near a swimming pool.
5. This product should never be placed near or over a radiator or heat register. It should not be placed in a built-in installation unless proper ventilation is provided.
6. This product should be operated only from the type of power source indicated on the marking label. If you are not sure of the type of power supply to your home, consult your dealer or local power company.
7. Do not allow anything to rest on the power cord. Do not locate this product where persons walking on it will damage the cord.

BATTERY PRECAUTIONS

SAFETY INSTRUCTIONS CONTINUED

8. Do not overload outlets and extension cords as this can result in risk of fire or electric shock.
9. Never push objects of any kind into this product as they may touch dangerous voltage points or short out parts that could result in a risk of fire or electric shock. Never spill liquid of any kind on the product.
10. To reduce the risk of electric shock, do not disassemble.
11. Use caution when installing or modifying telephone lines.
12. This product is intended to be supplied by a Listed Class 2 Direct Plug-In Power Unit rated 9VDC 350mA. Plantronics Part No. 63539-01, rated at an input voltage of 120 VAC, 60Hz and 6 W.
13. This product requires AC power in order to operate. In order to have phone service during a power outage, have another telephone available that is powered only by the telephone line.
14. Keep all product cords and cables away from operating machinery.
15. Avoid using a telephone (other than a cordless type) during an electrical storm. There may be a remote risk of electric shock from lightning.
16. Do not use the telephone to report a gas leak in the vicinity of the leak.

⚠ To reduce the risk of fire or injury to persons, read and follow these instructions.

1. Use only the battery pack supplied with this product.
2. Do not dispose of battery pack in a fire. The cells may explode. Check with local codes for possible disposal instructions.
3. Do not open or mutilate battery pack. Released electrolyte is corrosive and may cause damage to eyes or skin and may be toxic if swallowed.
4. Exercise care in handling the battery pack in order not to short the battery contacts with conducting materials such as rings, bracelets, and keys. The battery or conductor may overheat and cause burns.
5. Charge the battery pack in accordance with instructions supplied with this unit.
6. Observe proper orientation between battery pack and charger contacts.

SAVE THESE INSTRUCTIONS

Printed in USA, 64004-01 (9-04)
Sweden 64 176 and 64 177; Taiwan 085270; 085271 and 085272; Patents Pending
Regd. Des. No. 2,073,246; 2,073,247 and 3,004,998; Korea 323662; Spain 154568;
23426; France 680 853 - 680 872; Germany M 98 02 622.4 and 40205487.3; GB
China ZL 02331856.2; European Community 4393-0001; Finland 20183; 20184 and
Patents U.S. 5,210,791; 6,449,374; D394,437; D403,327; D475,694 and D480,072.
or registered trademarks of Plantronics, Inc.
Plantronics and the logo design combined, FlexGrip, and Firefly are trademarks
© 2003 Plantronics, Inc. All rights reserved. Plantronics, the logo design,

www.plantronics.com
(800) 544-4660
Santa Cruz, California 95060
345 Encinal Street

FCC REGISTRATION INFORMATION

FCC Requirements—Part 15

This device complies with Part 15 of the FCC Rules. Operation is subject to the following two conditions:

1. This device may not cause harmful interference, and
2. This device must accept any interference received, including interference that may cause undesired operation.

This equipment has been tested and found to comply with the limits for a Class B digital device, pursuant to Part 15 of the FCC Rules. These limits are designed to provide reasonable protection against harmful interference in a residential installation. This equipment generates, uses, and can radiate radio frequency energy and, if not installed and used in accordance with the instructions, may cause harmful interference to radio communications.

However, there is no guarantee that interference will not occur in a particular installation. If this equipment does cause harmful interference to radio or television reception which can be determined by turning the radio or television off and on, the user is encouraged to try to correct interference by one or more of the following measures:

1. Reorient or relocate the receiving antenna.
2. Increase the separation between the equipment and receiver.
3. Connect the equipment into an outlet on another circuit.
4. Consult the dealer or an experienced radio/TV technician for help.

The FCC Want You To Know

Changes or modifications to this product not expressly approved by Plantronics, or operation of this product in any way other than as detailed by the owner's manual, could void your authority to operate this product.

FCC Requirements—Part 68

This equipment complies with Part 68 of the FCC Rules. The FCC Part 68 Label is located on the bottom of the unit. This label contains the FCC Registration Number and Ringer Equivalence Number (REN) for this equipment. If requested this information must be provided to your telephone company.

The REN is useful to determine the quantity of devices you may connect to your telephone line and still have all of those devices ring when your telephone number is called. In most, but not all areas, the sum of the RENs of all devices connected to one line should not exceed five (5.0). To be certain of the number of devices you may connect to your line, as determined by the REN, you should contact your local

telephone company to determine the maximum REN for your calling area.

Connection to the telephone network should be made by using standard modular telephone jacks, type RJ11. The plug and/or jacks used must comply with FCC Part 68 rules. If this telephone equipment causes harm to the telephone network, the telephone company will notify you in advance that temporary discontinuance of service may be required. But if advance notice isn't practical, the telephone company will notify the customer as soon as possible. Also, you will be advised of your right to file a complaint with the FCC if you believe it is necessary.

The telephone company may make changes in its facilities, equipment, operations or procedures that could affect the proper functioning of your equipment. If they do, you will be notified in advance in order for you to make necessary modifications to maintain uninterrupted service.

NOTE: If your home has specially wired alarm equipment connected to the telephone line, be sure that installing the system does not disable your alarm equipment. If you have questions about what will disable your alarm equipment, contact your telephone company or a qualified installer.

INDUSTRY CANADA NOTICE

TERMINAL EQUIPMENT

NOTE: This equipment meets the applicable Industry Canada Terminal Equipment Technical Specifications. This is confirmed by the registration number. The abbreviation, IC, before the registration number signifies that registration was performed based on a Declaration of Conformity indicating that Industry Canada technical specifications were met. It does not imply that Industry Canada approved the equipment.

NOTE: The Ringer Equivalence Number (REN) for this terminal equipment is marked on the equipment itself. The REN assigned to each terminal equipment provides an indication of the maximum number of terminals allowed to be connected to a telephone interface. The termination on an interface may consist of any combination of devices subject only to the requirement that the sum of the Ringer Equivalence Numbers of all the devices does not exceed five.

RADIO EQUIPMENT

The term "IC:" before the radio certification number only signifies that Industry Canada technical specifications were met.

Operation is subject to the following two conditions: (1) this device may not cause interference, and (2) this device must accept any interference, including interference that may cause undesired operation of the device. "Privacy of communications may not be ensured when using this telephone".

LIMITED WARRANTY for Plantronics Commercial Products Purchased in the US and Canada

- This warranty covers defects in materials and workmanship of Commercial Products manufactured, sold or certified by Plantronics which were purchased and used in the United States and Canada.
- This warranty lasts for one year from the date of purchase of the Products.
- This warranty extends to you only if you are the end user with the original purchase receipt.
- We will, at our option, repair or replace the Products that do not conform to the warranty. We may use functionally equivalent reconditioned/refurbished/remanufactured/pre-owned or new Products or parts.
- To obtain service in the U.S. contact Plantronics at (800) 544-4660 and in Canada call (800) 540-8363. If you need additional information, please contact our service centers at the numbers provided.
- THIS IS PLANTRONICS' COMPLETE WARRANTY FOR THE PRODUCTS.
- This warranty gives you specific legal rights, and you may also have other rights which vary from state to state or province to province. Please contact your dealer or our service center for the full details of our limited warranty, including items not covered by this limited warranty.

The Plantronics Technical Assistance Center (TAC) is ready to assist you! Dial (800) 544-4660 x5538 Sunday 5p.m. through Friday, 5p.m. Pacific Time or visit the Support section of our website at www.plantronics.com. For accessibility information also call the Technical Assistance Center.

EXAMINE THE COMPONENTS OF THE CT11/12 SYSTEM

BASE

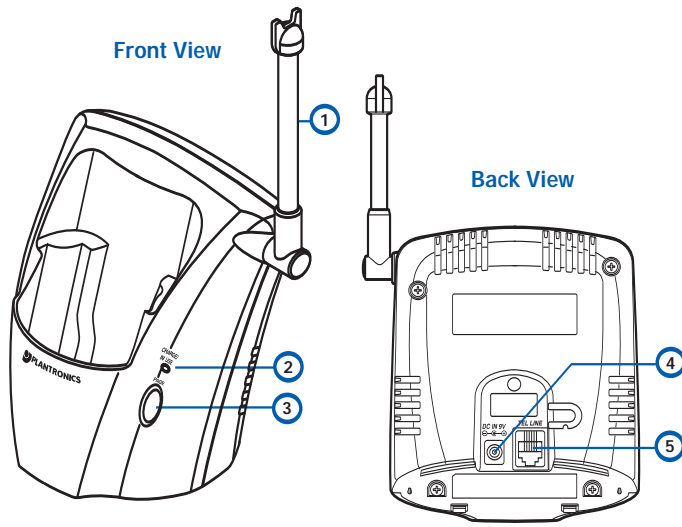

BASE

- 1 Base Antenna/ Headset Holder
- 2 CHARGE/IN USE Indicator
- 3 PAGE key
- 4 DC Power Input
- 5 Telephone Line Jack

TELEPHONE REMOTE

- 6 Headset Jack
- 7 MESSAGE WAITING Indicator*
- 8 Caller ID* and Display
- 9 TALK/FLASH Key
- 10 (phonebook)/ (left cursor)/ SPEED (Speed Dial) Key

*Must be activated through your local phone company.

TELEPHONE REMOTE

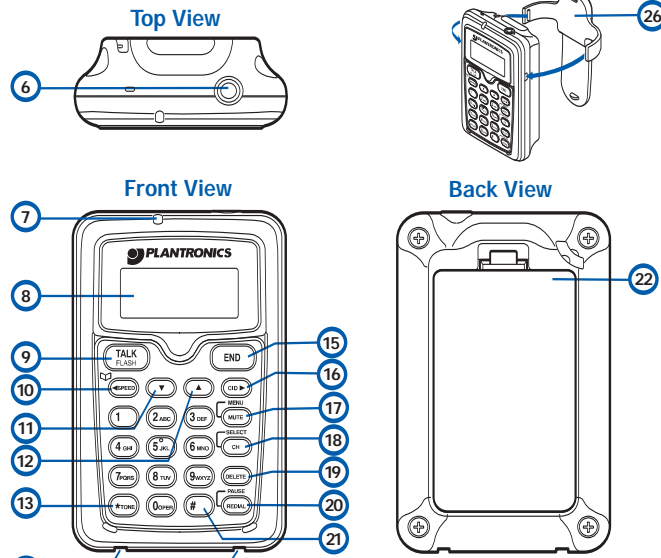

TELEPHONE REMOTE

- 11 ▼ DOWN Key
- 12 ▲ UP Key
- 13 * TONE Key
- 14 Remote Charging Contacts
- 15 END Key
- 16 CID (Caller ID)*/ (right cursor) Key
- 17 MENU/MUTE Key
- 18 SELECT/CH (channel) Key
- 19 DELETE Key
- 20 PAUSE/REDIAL Key
- 21 # Key
- 22 Remote Battery Compartment Cover

Also supplied:

- 23 AC Adapter (not shown)
- 24 Battery Pack (not shown)
- 25 Telephone Cord (not shown)
- 26 Belt Clip

CT12 CONVERTIBLE HEADSET with Firefly™

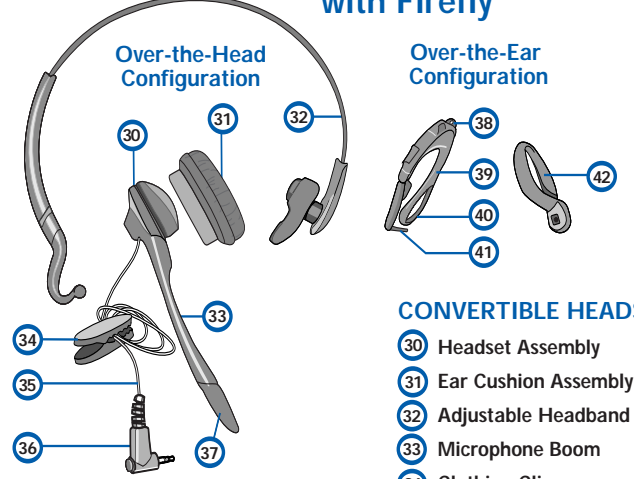

CONVERTIBLE HEADSET

- 30 Headset Assembly
- 31 Ear Cushion Assembly
- 32 Adjustable Headband
- 33 Microphone Boom
- 34 Clothing Clip
- 35 Cord
- 36 2.5 mm Plug
- 37 Firefly In-use Indicator
- 38 Cord Retainers
- 39 Earloop, Flexible
- 40 Thumb Loop
- 41 Pin for Pivot Ball Ring Hole
- 42 Pivot Ball Ring

CT11 HEADSET In-the-Ear Headset

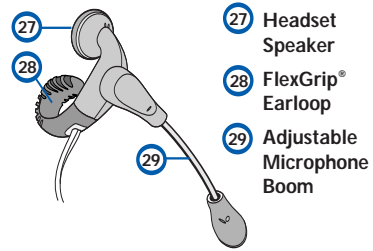

CT11/12 CORDLESS TELEPHONE HEADSET SYSTEM

1 Install Battery Pack

1.1 Squeeze open the latch on the Remote Battery Compartment Cover (22) and lift the cover.

1.2 Connect the Battery Pack (24) connector using the correct polarity. Do not force. Plastic connectors will fit in only one way.

1.3 Insert battery pack into the battery compartment. Do not let wires hang out, tuck them in.

1.4 Insert tabs of cover into slots and push down to securely close the cover.

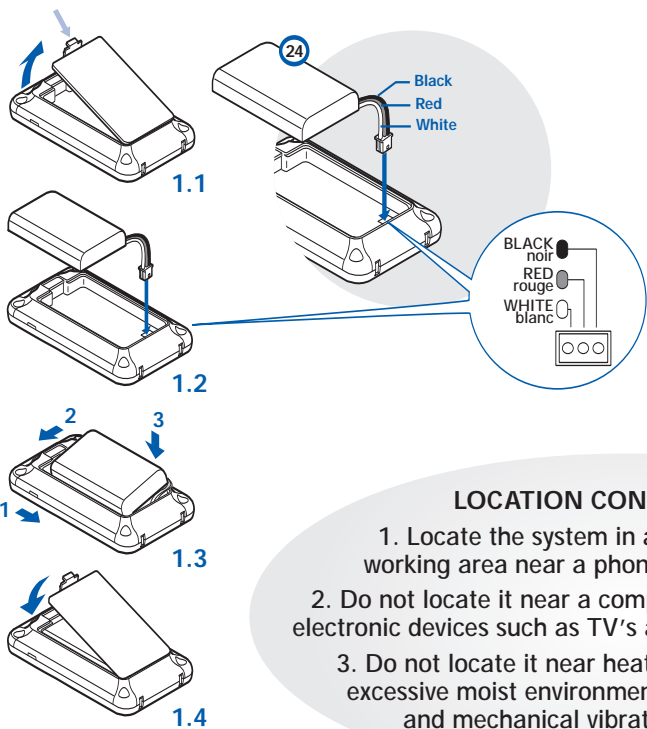

2 Set Up the Base

2.1 Connect the AC adapter power cord to the base and an active AC outlet.

2.2 Route the power cord as shown in the detail drawing allowing clearance for the telephone plug to be inserted.

2.3 Insert the remote into the charging cradle on the base. Charge for 15 hours. The CHARGE/ IN USE indicator (2) light will go on.

2.4 Raise Base Antenna (1) to a vertical position.

2.5 Once the remote is fully charged, plug one end of the telephone cord into the base and plug the other end into an active telephone outlet.

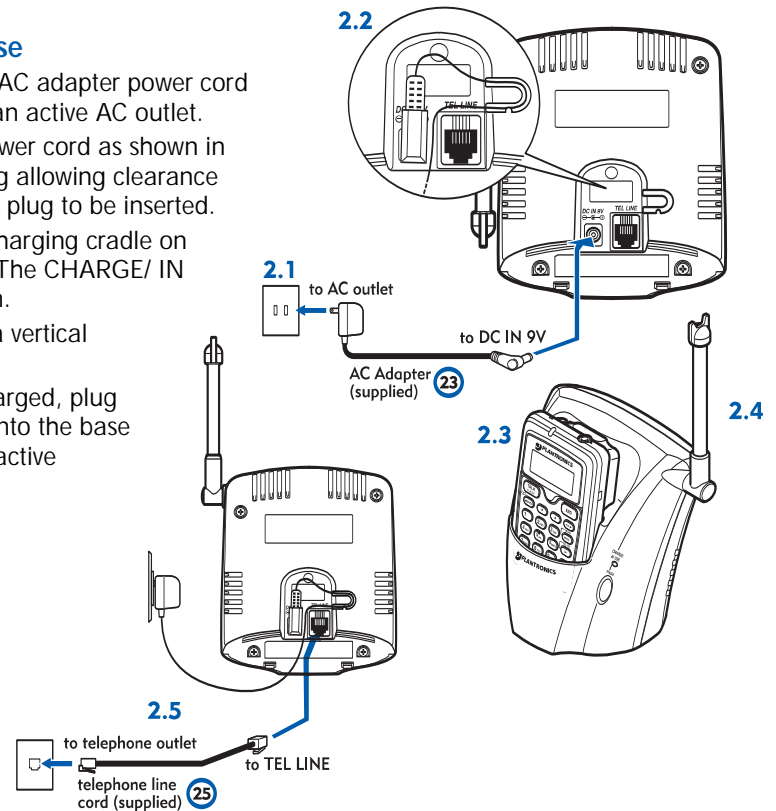

LOCATION CONSIDERATIONS

1. Locate the system in a central part of your working area near a phone and a power outlet.
2. Do not locate it near a computer, microwave, or other electronic devices such as TV's and other cordless devices.
3. Do not locate it near heat sources, noise sources, excessive moist environments, dusty environments, and mechanical vibration environments.

3 Install CT11 Headset

Mount headset and point boom toward mouth.

Install CT12 Headset

Your Convertible Headset can be configured for over-the-ear or over-the-head use.

For over-the-ear use

3.1 Press the headset to your ear, then loop the Earloop (39) behind the ear as shown.

3.2 Adjust the tip of the Microphone Boom (33) toward the corner of your mouth.

3.3 Plug the headset cord into the 2.5mm jack on the top of the remote.

3.4 Route the cord through the handset's cord retainer slot.

Or over-the-head use

3.5 Place the headset on your head so the speaker covers your ear.

3.6 Adjust the tip of the microphone boom toward the corner of your mouth.

3.7 Repeat 3.3 and 3.4

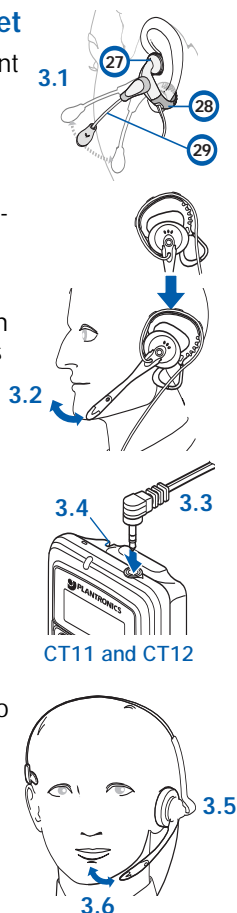

4 Make Basic Setting Changes, if necessary

4.1 Language option

The default language is English.

To change to French or Spanish:

1. When in Standby mode**, press the MENU/MUTE (17) key.
2. Press the ▲ or ▼ key to move the pointer to language of choice.
3. Press the SELECT/CH (18) key to select language.
4. Press the END (15) key to exit.

4.2 Dialing mode option

Most phone systems use tone dialing, which sends DTMF tones through the phone lines. However some phone systems in rural areas still use pulse dialing. The default setting is tone dialing.

To change the dialing mode:

1. When in Standby mode**, press the Menu/Mute key.
2. Press the ▲ or ▼ key to move the pointer from Tone Dialing to Pulse Dialing.
3. Press the Select/Ch key to select the dialing mode.
4. Press the End key to exit.

**Standby mode—The remote is not in use, it is off the base, and the TALK/FLASH (9) key has not been pressed. A dial tone is not heard and the display is blank.

This standby mode is starting point for most activity.

5 Make and Receive Test Calls

With your headset mounted from Step 3 and any required setting changes made from Step 4, prepare to make your first call.

5.1 To make your first call

1. Remove remote from its base.
2. In the standby mode, dial the number as you would on an ordinary phone.
3. Push the Talk/Flash key. After about two seconds you will hear the number being dialed.
4. Talk once you connect.
5. Adjust the listen volume to Low, Medium, High, or Maximum for your hearing comfort using the ▲ or ▼ keys.
6. Press the End key to disconnect and hang up the call.



5.2 To redial

1. In the standby mode, press the PAUSE/REDIAL key (20) once. The last number dialed will be displayed on the screen.
2. Press the Talk/Flash key to dial it.

Tips: 1) If the Talk/Flash key was pushed first and then you pushed the Pause/Redial key, the last number dialed will be immediately redialed. 2) The Pause/Redial key will store your last three numbers dialed.

5.3 To answer a call

1. Press the Talk/Flash key and begin talking.
2. Press the End key to disconnect and hang up the call.

5.4 To mute a call

1. Press and hold the Menu/Mute key for **3 full seconds**. You will hear an activating beep and see Mute on the display.
2. Press the mute button to toggle off mute.
3. Press the End key or put the remote back into the base charging cradle to disconnect and end the call.