

Explorer 100 Series

User guide

Contents

What's in the box	3
Headset overview	4
Be safe	4
Pair	5
Get paired	5
Pair mode	5
Basics	6
Answer or end a call	6
Adjust the volume	6
Mute	6
Redial	6
Voice control	6
Select language	6
Pair mode	6
Charge and fit	7
Charge	7
Adjust the fit	7
Headset features	8
Music and more	8
Decipher the lights	8
Voice prompts	8
DeepSleep mode	8
Install the app	8
Specifications	9
Support	10

What's in the box



Headset

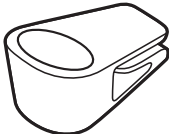

Car vent clip*



Vehicle power charger*

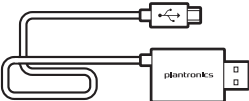

2-in-1 combo cable*

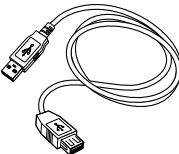

Micro USB cable*

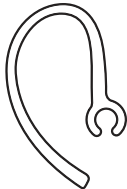







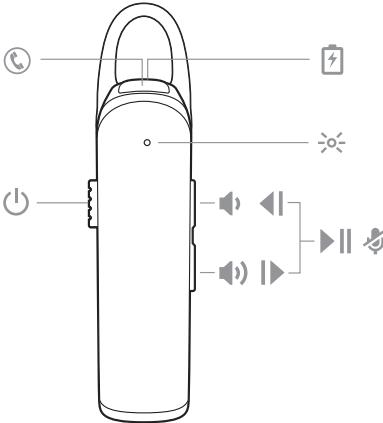



Optional ear loop

NOTE *Accessories may vary by product.

Headset overview



	Call button
	Charge port
	Headset LED (indicator light)
	Power button
	Volume up
	Volume down
	Track back
	Track forward
	Play/pause
	Mute

Be safe

Please read the safety guide for important safety, charging, battery and regulatory information before using your new headset.

Pair

Get paired The first time you power on your headset, the pairing process begins.

- 1 Slide the power switch on. You hear "pairing" and the indicator  light flashes red and blue.

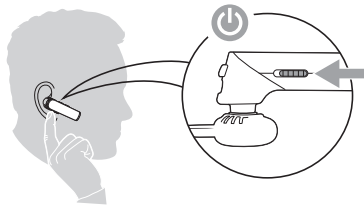

- 2 Activate Bluetooth® on your phone and set it to search for new devices.

- **iPhoneSettings** > **Bluetooth** > **On***
- **AndroidSettings** > **Bluetooth:On** > **Scan for devices***

NOTE *Menus may vary by device.

- 3 Select "PLT E100 Series".

If necessary, enter four zeros (0000) for the passcode or accept the connection.

Once successfully paired, you hear "pairing successful" and the indicator  light stops flashing.

Pair mode

While wearing your headset, power it on. Press and hold the Call  button until you hear "pairing". You can pair up to two devices to your headset.

Basics

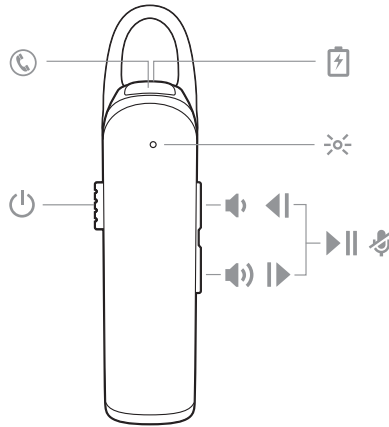

Answer or end a call

Tap the Call ☎ button.

Adjust the volume

Tap the Volume up 🔊 or Volume down 🔊 button.

Mute

During a conversation, press both the Volume up 🔊 and Volume down 🔊 buttons for 2 seconds until you hear "mute on" or "mute off".

Redial

Double-tap the Call ☎ button to call the last number you dialed.

Voice control

Siri, Google Now™, Cortana Press the Call ☎ button for 2 seconds and wait for the phone prompt to activate voice dialling, search, and other smartphone voice controls.

Select language

Press and hold the Volume up 🔊 and down 🔊 buttons together until you hear "welcome". Follow the voice-guided prompts to select the headset language.*

NOTE *Language selection not available in Europe, Russia and Africa.

Pair mode

While wearing your headset, power it on. Press and hold the Call ☎ button until you hear "pairing". You can pair up to two devices to your headset.

Charge and fit

Charge

It takes 2 hours to fully charge the headset; the indicator  light turns off once charging is complete.

Adjust the fit

The universal-fit ear tip has a thin loop that bends to gently tuck into the contours of either ear. To adjust the fit, you can rotate the ear tip on the headset or add the optional clip-on ear loop.

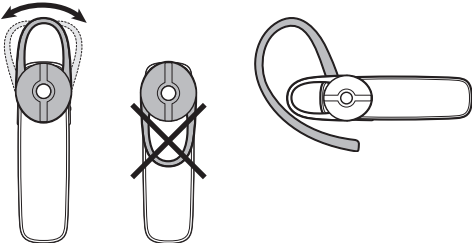

Headset features

Music and more Listen to your music, podcasts, navigation and other streaming audio on your headset.

Play or pause audio

Press both Volume buttons at the same time.

Skip to next track

Press the Volume up  button for 2 seconds.

Play previous track

Press the Volume down  button for 2 seconds to restart current track. Press the button twice (each button press 2 seconds) to go to previous track.

Decipher the lights

Your headset has an indicator light  that flashes in response to a change in status or after a button press.

Some examples of what you will see are:

- Solid red until charging is complete and then solid blue
- Flashing red and blue during pairing
- Double red flash when battery is low
- Double blue flash at incoming call

Voice prompts

Your headset tells you about status changes. For example:

"Power on"

"Pairing successful"

"Phone 1 connected"

"Talk time (x) hours"

"Mute on"

"Answering call"

"Recharge headset"

DeepSleep mode

If you leave your headset powered on but out of range of your paired phone for more than 120 minutes, your headset will conserve its battery power by entering into a DeepSleep® mode.

Once back in range with your phone, press any button to exit DeepSleep mode. If your phone is also ringing, tap the Call  button again to answer your call.

Install the app

Get the most from your headset by installing our free mobile app, Plantronics Hub for iOS/Android. Explore all of your headset's features, view instructions, and contact Plantronics support easily from your smartphone.

plantronics.com/apps



Specifications

Talk time	Up to 7 hours
Standby time	Up to 11 days
Operating Distance (Range)	Up to 33 feet (10 metres) from phone or table, Class II
Headset Weight	7.8 grams
Charge Connector	Micro USB charging
Battery type	Rechargeable non-replaceable lithium ion polymer
Charge Time (Maximum)	2 hours for full charge
DeepSleep mode	Provides up to 180 days
Power requirements	5 V DC – 150 mA
Bluetooth Version	Bluetooth v4.1
Bluetooth profiles	Hands-Free Profile v1.6 (HFP), Headset Profile v1.2 (HSP), Simple Secure Pairing (SSP)
Moisture Protection	No
Operating Temperature	32 – 102°F (0 – 40°C)
Storage Temperature	32 – 102°F (0 – 40°C)
Charging Temperature	32 – 104°F (0 – 40°C)

Support

EN 0800 410014	FI 0800 117095	NO 80011336
AR +44 (0)1793 842443*	FR 0800 945770	PL +44 (0)1793 842443*
CS +44 (0)1793 842443*	GA 1800 551 896	PT 800 84 45 17
DA 80 88 46 10	HE +44 (0)1793 842443*	RO +44 (0)1793 842443*
DE Deutschland 0800 9323 400 Österreich 0800 242 500 Schweiz 0800 932 340	HU +44 (0)1793 842443*	RU 8-800-100-64-14 +44 (0)1793 842443*
EL +44 (0)1793 842443*	IT 800 950934	SV 0200 21 46 81
ES 900 803 666	NL NL 0800 7526876 BE 0800 39202 LUX 800 24870	TR +44 (0)1793 842443*

**Support in English*

For warranty details, go to plantronics.com/warranty.

NEED MORE HELP?

plantronics.com/support

plantronics®
Simply Smarter Communications™

Plantronics, Inc.

345 Encinal Street
Santa Cruz, CA 95060
United States

Plantronics BV

South Point Building C
Scorpius 140
2132 LR Hoofddorp, Netherlands

© 2016 Plantronics, Inc. DeepSleep and Plantronics are trademarks of Plantronics, Inc. registered in the US and other countries. Explorer, Find MyHeadset, Plantronics Hub and PLT are trademarks of Plantronics, Inc. Bluetooth is a registered trademark of Bluetooth SIG, Inc. and any use by Plantronics is under licence. Apple, the Apple logo, iPhone, and Siri are trademarks of Apple Inc., registered in the US. and other countries. All other trademark are the property of their respective owners.

Patents: US 9,264,792; D717,771; patents pending.

206923-07 (07.16)