



Hardware Guide

Version 8.5.0 | December 2014 | DOC2751A

RealPresence Collaboration Server (RMX) 1500



Copyright© 2014, Polycom, Inc. All rights reserved. No part of this document may be reproduced, translated into another language or format, or transmitted in any form or by any means, electronic or mechanical, for any purpose, without the express written permission of Polycom, Inc.

6001 America Center Drive
San Jose, CA 95002
USA



Polycom®, the Polycom logo and the names and marks associated with Polycom products are trademarks and/or service marks of Polycom, Inc. and are registered and/or common law marks in the United States and various other countries. All other trademarks are property of their respective owners. No portion hereof may be reproduced or transmitted in any form or by any means, for any purpose other than the recipient's personal use, without the express written permission of Polycom.



Java is a registered trademark of Oracle America, Inc., and/or its affiliates.

End User License Agreement By installing, copying, or otherwise using this product, you acknowledge that you have read, understand and agree to be bound by the terms and conditions of the End User License Agreement for this product. The EULA for this product is available on the Polycom Support page for the product.

Patent Information The accompanying product may be protected by one or more U.S. and foreign patents and/or pending patent applications held by Polycom, Inc.

Open Source Software Used in this Product This product may contain open source software. You may receive the open source software from Polycom up to three (3) years after the distribution date of the applicable product or software at a charge not greater than the cost to Polycom of shipping or distributing the software to you.

Disclaimer While Polycom uses reasonable efforts to include accurate and up-to-date information in this document, Polycom makes no warranties or representations as to its accuracy. Polycom assumes no liability or responsibility for any typographical or other errors or omissions in the content of this document.

Limitation of Liability Polycom and/or its respective suppliers make no representations about the suitability of the information contained in this document for any purpose. Information is provided "as is" without warranty of any kind and is subject to change without notice. The entire risk arising out of its use remains with the recipient. In no event shall Polycom and/or its respective suppliers be liable for any direct, consequential, incidental, special, punitive or other damages whatsoever (including without limitation, damages for loss of business profits, business interruption, or loss of business information), even if Polycom has been advised of the possibility of such damages.

Customer Feedback We are striving to improve our documentation quality and we appreciate your feedback. Email your opinions and comments to DocumentationFeedback@polycom.com.

Polycom Support Visit the [Polycom Support Center](#) for End User License Agreements, software downloads, product documents, product licenses, troubleshooting tips, service requests, and more.

Regulatory Notices



Warning

- No user-serviceable parts inside. Do not open.
- The plug-socket combination must be accessible at all times, because it serves as the main disconnecting device.
- This equipment must be earthed. Do not power this equipment if the integrity of the main earthing conductor cannot be verified.
- Only trained and qualified personnel should be allowed to install, replace, service or repair this equipment.
- To prevent system overheating do not operate in an ambient temperature exceeding 40° C / 104° F.
- Installation of this equipment must comply with local and national electrical codes.

Environmental

This product is compliant with the requirements of the recast RoHS Directive 2011/65/EU. Information can be obtained from Polycom Ltd, 270 Bath Road, Slough, Berkshire, SL1 4DX, UK or via:

RoHSinformation@polycom.com

Information on recycling can be found at: www.polycom.com/WEEE

Disposal of this equipment should be carried out in accordance with local environmental guidelines and regulations for waste. For further information please contact: TakeBack@polycom.com

Batteries

Below is a listing of batteries that could be present in the product:

Description: Internal CMOS battery

Type: CR2032 Lithium Coin Cell

Weight: 3.3g

Batteries used in this product are in compliance with EU Battery Directive 2006/66/EC.

Batteries in this product are not based on mercury, lead or cadmium technologies.

Batteries in this product are not intended to be replaced or removed by the user

Additional information on the safe use and recycling of batteries can be found at: www.polycom.com/batteries

United States Federal Communication Commission (FCC)

This equipment has been tested and found to comply with the limits for a Class A digital device, pursuant to Part 15 of the FCC Rules. These limits are designed to provide reasonable protection against harmful interference when the equipment is operated in a commercial environment. This equipment generates, uses, and can radiate radio frequency energy and, if not installed and used in accordance with the instruction manual, may cause harmful interference to radio communications. Operation of this equipment in a residential area is likely to cause harmful interference in which case the user will be required to correct the interference at his own expense.

This device complies with Part 15 of the FCC Rules. Operation is subject to the following two conditions:

1. This device may not cause harmful interference.
2. This device must accept any interference received, including interference that may cause undesired operation.

Modifications: Any modifications made to this device that are not approved by Polycom, Inc. may void the authority granted to the user by the FCC to operate this equipment.

Industry Canada (IC)

This Class [A] digital apparatus complies with Canadian ICES-003
Cet appareil numérique de la classe [A] est conforme a la norme NMB-003 du Canada

European Economic Area (EEA)

Česky [Czech]:	Polycom (UK) Ltd tímto prohlašuje, že tento Polycom RMX je ve shodě se základními požadavky a dalšími příslušnými ustanoveními směrnice 1999/5/ES.
Dansk [Danish]:	Undertegnede Polycom (UK) Ltd erklærer herved, at følgende udstyr Polycom RMX overholder de væsentlige krav og øvrige relevante krav i direktiv 1999/5/EF.
Deutsch [German]:	Hiermit erkläre Polycom (UK) Ltd, dass sich das Gerät Polycom RMX in Übereinstimmung mit den grundlegenden Anforderungen und den übrigen einschlägigen Bestimmungen der Richtlinie 1999/5/EG befindet.
Eesti [Estonian]:	Käesolevaga kinnitab Polycom (UK) Ltd seadme Polycom RMX vastavust direktiivi 1999/5/EÜ põhinõuetele ja nimetatud direktiivist tulenevatele teistele asjakohastele sätetele.
English:	Hereby, Polycom (UK) Ltd. Declares that this Polycom RMX is in compliance with the essential requirements and other relevant provisions of Directive 1999/5/EC.
Español [Spanish]:	Por medio de la presente Polycom (UK) Ltd declara que el Polycom RMX cumple con los requisitos esenciales y cualesquiera otras disposiciones aplicables o exigibles de la Directiva 1999/5/CE.
Ελληνική [Greek]:	ΜΕ ΤΗΝ ΠΑΡΟΥΣΑ Polycom (UK) Ltd ΔΗΛΩΝΕΙ ΟΤΙ Polycom RMX ΣΥΜΜΟΡΦΩΝΕΤΑΙ ΠΡΟΣ ΤΙΣ ΟΥΣΙΩΔΕΙΣ ΑΠΑΙΤΗΣΕΙΣ ΚΑΙ ΤΙΣ ΛΟΙΠΕΣ ΣΧΕΤΙΚΕΣ ΔΙΑΤΑΞΕΙΣ ΤΗΣ ΟΔΗΓΙΑΣ 1999/5/ΕΚ.
Français [French]:	Par la présente Polycom (UK) Ltd déclare que l'appareil Polycom RMX est conforme aux exigences essentielles et aux autres dispositions pertinentes de la directive 1999/5/CE.

European Economic Area (EEA)	
Italiano [Italian]:	Con la presente Polycom (UK) Ltd dichiara che questo Polycom RMX è conforme ai requisiti essenziali ed alle altre disposizioni pertinenti stabilite dalla direttiva 1999/5/CE.
Íslenska (Icelandic):	Hér með lýsir Polycom (UK) Ltd yfir því að Polycom RMX er í samræmi við grunnkröfur og aðrar kröfur, sem gerðar eru í tilskipun 1999/5/EC.
Latviski [Latvian]:	Ar šo Polycom (UK) Ltd deklarē, ka Polycom RMX atbilst Direktīvas 1999/5/EK būtiskajām prasībām un citiem ar to saistītajiem noteikumiem.
Lietuvių [Lithuanian]:	Šiuo Polycom (UK) Ltd deklaruoja, kad šis Polycom RMX atitinka esminius reikalavimus ir kitas 1999/5/EB Direktyvos nuostatas.
Nederlands [Dutch]:	Hierbij verklaart Polycom (UK) Ltd dat het toestel Polycom RMX in overeenstemming is met de essentiële eisen en de andere relevante bepalingen van richtlijn 1999/5/EG.
Malti [Maltese]:	Hawnhekk, Polycom (UK) Ltd, jiddikjara li dan Polycom RMX jikkonforma mal-ħtiġijiet essenzjali u ma provvedimenti oħrajn relevanti li hemm fid-Dirrettiva 1999/5/EC.
Magyar [Hungarian]:	Alulírott, Polycom (UK) Ltd nyilatkozom, hogy a Polycom RMX megfelel a vonatkozó alapvető követelményeknek és az 1999/5/EC irányelv egyéb előírásainak.
Norsk [Norwegian]:	Polycom (UK) Ltd erklærer herved at utstyret Polycom RMX er i samsvar med de grunnleggende krav og øvrige relevante krav i direktiv 1999/5/EF.
Polski [Polish]:	Niniejszym Polycom (UK) Ltd oświadcza, że Polycom RMX jest zgodne z zasadniczymi wymaganiami oraz innymi stosownymi postanowieniami Dyrektywy 1999/5/WE.
Português [Portuguese]:	Polycom (UK) Ltd declara que este Polycom RMX está conforme com os requisitos essenciais e outras disposições da Directiva 1999/5/CE.
Slovensko [Slovenian]:	Polycom (UK) Ltd týmto vyhlasuje, že Polycom RMX spĺňa základné požiadavky a všetky príslušné ustanovenia Smernice 1999/5/ES.
Slovensky [Slovak]:	Polycom (UK) Ltd týmto vyhlasuje, že Polycom RMX spĺňa základné požiadavky a všetky príslušné ustanovenia Smernice 1999/5/ES.
Suomi [Finnish]:	Polycom (UK) Ltd vakuuttaa täten että Polycom RMX tyyppinen laite on direktiivin 1999/5/EY oleellisten vaatimusten ja sitä koskevien direktiivin muiden ehtojen mukainen.
Svenska [Swedish]:	Härmed intygar Polycom (UK) Ltd att denna Polycom RMX står i överensstämmelse med de väsentliga egenskapskrav och övriga relevanta bestämmelser som framgår av direktiv 1999/5/EG.

A full copy of the Declaration of Conformity can be obtained from Polycom Ltd, 270 Bath Road, Slough, Berkshire, SL1 4DX, UK.

China CCC EMC statement

警告

此为 A 级产品，在生活环境中，该产品可能会造成无线电干扰。在这种情况下，可能需要用户对干扰采取切实可行的措施。

Taiwan BSMI EMC statement

声明

此为 A 级产品，在生活环境中，该产品可能会造成无线电干扰。在这种情况下，可能需要用户对其干扰采取切实可行的措施。

Japan VCCI EMC statement

この装置は、クラスA情報技術装置です。この装置を家庭環境で使用すると電波妨害を引き起こすことがあります。この場合には使用者が適切な対策を講ずるよう要求されることがあります。 VCCI-A

This is a Class A product based on the standard of the Voluntary Control Council for Interference by Information Technology Equipment (VCCI). If this equipment is used in a domestic environment, radio disturbance may arise. When such trouble occurs, the user may be required to take corrective actions.

Worldwide EMC statement

This is a class A product. In a domestic environment this product may cause radio interference in which case the user may be required to take adequate measures.

Optional ISDN interface card

If the above is fitted to the system then the following statements also apply;

United States Federal Communication Commission (FCC)

This equipment complies with Part 68 of the FCC rules and the requirements adopted by the ACTA. On the ISDN card itself is a label that contains, among other information, a product identifier in the format US:AAAEQ##TXXXX. If requested, this number must be provided to the telephone company.

The following USOC, FIC and SOC codes are applicable to this equipment;

USOC Jacks: RJ48S

Service Order Code: 6.0N

Facility Interface Code: 04DU9.DN, 04DU9.BN, 04DU9.1KN, 04DU9.1SN

If this equipment causes harm to the telephone network, the telephone company will notify you in advance that temporary discontinuance of service may be required. But if advance notice isn't practical, the telephone company will notify the customer as soon as possible. Also, you will be advised of your right to file a complaint with the FCC if you believe it is necessary.

The telephone company may make changes in its facilities, equipment, operations or procedures that could affect the operation of the equipment. If this happens the telephone company will provide advance notice in order for you to make necessary modifications to maintain uninterrupted service.

If trouble is experienced with this equipment, for repair or warranty information, please contact Polycom Inc in the U.S.A. 1-888-248-8294. If the equipment is causing harm to the telephone network, the telephone company may request that you disconnect the equipment until the problem is resolved.

Connection to party line service is subject to state tariffs. Contact the state public utility commission, public service commission or corporation commission for information.

Contents

Hardware Description	9
Main Features	9
RealPresence Collaboration Server (RMX) 1500 Specifications	10
RealPresence Collaboration Server (RMX) 1500 System Capacities	11
Conferencing Capacities	11
Resource Capacities	12
Site Requirements	13
Safety Requirements	13
Rack Mount Safety Precautions	13
Installation Precautions	14
Installing the RealPresence Collaboration Server (RMX) 1500	14
Unpacking the RealPresence Collaboration Server (RMX) 1500	14
Installing the RTM ISDN 1500 Card on the RealPresence Collaboration Server (RMX) 1500	15
Telescopic Rail Runner Assembly for RealPresence Collaboration Server (RMX) 1500	16
Assembling the Telescopic Rail Runner	17
Mounting the RealPresence Collaboration Server (RMX) 1500 on a Shelf	20
Connecting the RealPresence Collaboration Server (RMX) 1500 to a Power Source ...	20
Connecting the RealPresence Collaboration Server (RMX) 1500 to AC Power	21
Connecting Cables to the RealPresence Collaboration Server (RMX) 1500	21
First-time Power-up	22
RealPresence Collaboration Server (RMX) 1500 Components	23
RealPresence Collaboration Server (RMX) 1500 Front Panel	23
Opening the Collaboration Server (RMX) 1500 Front Panel	23
Front Panel Components	24
RealPresence Collaboration Server (RMX) 1500 Rear Panel	25
RTM IP 1500	25
RTM ISDN 1500	27
ISDN/PSTN Clock Source	27

RealPresence Collaboration Server (RMX) 1500 Power Supply	28
RealPresence Collaboration Server (RMX) 1500 LEDs	29
RealPresence Collaboration Server (RMX) 1500 Front Panel LEDs	29
RealPresence Collaboration Server (RMX) 1500 Rear Panel LEDs	29
RTM IP 1500 LEDs	29
RTM ISDN 1500 LEDs	30
Power Supply LEDs	31
Component Installation & Replacement	32
Installing or Replacing the RTM ISDN 1500 Card	32
Removing the Blank Cover or the Existing RTM ISDN 1500 Card from the RealPresence Collaboration Server (RMX) 1500	32
Installing a New or Replacement RTM ISDN 1500 Card	33
PRI Port Assignment	35

RealPresence Collaboration Server (RMX) 1500 Hardware Description

This Hardware Guide provides information on the *RealPresence Collaboration Server (RMX) 1500* and its components. This system utilizes a modular platform, whose components are designed for high performance, capacity, and reliance.



Polycom® RealPresence® Collaboration Server 1500 and RMX® 1500 are used interchangeably throughout this document.

Main Features

The *Polycom RealPresence Collaboration Server (RMX) 1500* offers the following features:

- Linux® based
- Support for standard network interfaces (H.323, SIP, ISDN, PSTN and LAN)
- New hardware technologies
- Telco grade high availability, on-line upgrading and dynamic resource allocation
- Easy integration of conference elements into external network management
- Enhanced Continuous Presence (multi-image video)
- IVR (Interactive Voice Response) module

RealPresence Collaboration Server (RMX) 1500 Specifications

RMX 1500 Specifications

Physical	
Height	1U (4.44 cm.)
Width	19" (48.26 cm.)
Depth	26.3" (60 cm.)
Weight	Up to 12 Kg (26.5 lbs).
Media Protocols	
Audio	G.711a/u, G.722, G.722.1C, G.722.1, G.723.1, G.719 G.729A, Polycom Siren™ 14, Siren 22 (in mono or stereo) and Siren LPR.
Video	H.261, H.263, H.264, H.264 High Profile
Network Interfaces	

RMX 1500 Specifications

Physical	
IP, ISDN, PSTN and LAN	H.323, SIP, ISDN, PSTN, VoIP and LAN
Power Supply	
AC Input/ Range, BTU	Voltage range: 100-240 VAC \pm 10%, 1.5-4 AMP, 50-60 Hz. Maximum BTU output: 1195 per hour.
Power Consumption	
AC Maximum Power consumption	400 Watts.
Environment	
Operating temperature	0° to 40°C (32° to 104°F).
Storage temperature	-40° to 70°C (-40° to 158° F).
Relative humidity	15% to 90% non-condensing.
Operating altitude	360m (1200ft) below sea level and up to 4Km (13,000ft)
Transit Storage	Sea level and up to 15Km (50,000ft)
Operating ESD	4 kV.

RealPresence Collaboration Server (RMX) 1500 System Capacities

Conferencing Capacities

The following table summarizes the different system capacities.

System Functions and Capacities RMX 1500 Series

System Functions	MPMx - Q	MPMx -S	MPMx -D
Maximum number of Video participants in a conference	25	45	90
Maximum number of PSTN participants in a conference	90	120	120
Maximum number of VOIP participants in a conference	90	180	360
Maximum number of Audio calls per second	5	5	5
Maximum number of Video calls per second	2	2	2

System Functions and Capacities RMX 1500 Series

System Functions	MPMx - Q	MPMx -S	MPMx -D
Maximum number of conferences	200	400	400
Maximum number of Meeting Rooms	1000	1000	1000
Maximum number of Entry Queues	40	40	40
Maximum number of Profiles	80	80	80
Maximum number of Conference Templates	100	100	100
Maximum number of SIP Factories	40	40	40
Maximum number of IP Services	2	2	2
Maximum number of ISDN Services	2	2	2
Maximum number of IVR Services	80	80	80
Maximum number of Recording Links	20 (default)	20 (default)	20 (default)
Maximum number of IVR Video Slides	150	150	150
Maximum number of Log Files (1Mb max.)	4000	4000	4000
Maximum number of CDR Files	2000	2000	4000
Maximum number of Fault Files	1000	1000	1000
Number of Participant alerts	Unlimited	Unlimited	Unlimited
Maximum number of concurrent RealPresence Collaboration Server Web Client connections to the MCU	20	20	20
Maximum number Address Book entries	4000	4000	4000
Maximum number of Users	100	100	100
Maximum number of Gateway Profiles	40	40	40
Maximum number of Reservations (Internal Scheduler)	2000	2000	2000

Resource Capacities

System Resources are now reported in terms of HD720p30 CP ports. One HD video port equals 3 CIF video ports.

System Resource Capacities per Resolution in CP Mode

Resource Type/Video Resolution	MPMx - Q	MPMx -S	MPMx - D
CIF H.263	14	30	60
CIF 30 H.264	25	45	90
CIF 60 H.264	14	30	60
SD 30/ 4CIF H.264	14	30	60
4CIF H.263	7	15	30
HD720p30/ 4CIF 60/ SD 60	7	15	30
HD1080p30fps/HD720p60	3	7	15 (Symmetric)
VOIP	90	180	360
PSTN	90	120	120
ISDN	25	60 (at 128 Kbps) - 4 E1/T1	60 (at 128 Kbps) - 4 E1/T1



On the *Collaboration Server (RMX) 1500* with a *MPMx-Q* media card, the use of *HD resolution* with *Continuous Presence* requires an additional license.

System Resource Capacities per Line Rate per Card Type in VSW Mode

Resource Type/ Line Rate	MPMx - Q	MPMx - S	MPMx -D
VSW 2Mb	20*	40*	80*
VSW 4Mb	10	20	40
VSW 6Mb	5	10	20
ISDN	25 (at 128 Kbps)	60 (at 128 Kbps)	60 (at 128 Kbps)

Site Requirements

This section describes the requirements your site must meet for the safe installation and operation of the system.

Safety Requirements

For your protection, please read these safety instructions completely before operating the equipment.

- Look carefully for potential hazards in your work area: moist floors, ungrounded power cables, frayed power cords, missing safety grounds and so forth.
- Locate the main circuit breaker within the room.
- Locate the emergency power **OFF** switch within the room.
- Never assume that power is disconnected from a circuit.
- Use only the power cord supplied with the system.
- The power cord should only be connected to a power outlet that has a protective ground contact.
- Ensure that the power cord is easily accessible from the back of the system at all times.
- Place the equipment in a well-ventilated area where the vents are free from obstruction.
- Do not place heavy objects directly on top of the Collaboration Server (RMX) 1500 unit.

Do not use liquids around your equipment.

Rack Mount Safety Precautions

The following precautions should be followed with regards to rack mount safety:

- Keep the area around the Collaboration Server (RMX) 1500 clean and free of clutter.
- Decide on a suitable location for the equipment rack that will hold the Collaboration Server (RMX) 1500 unit. It should be situated in a clean, dust-free area that is well ventilated. Avoid areas where heat, electrical noise and electromagnetic fields are generated. You will also need it placed near a grounded power outlet.
- Ensure that the leveling jacks on the bottom of the rack are fully extended to the floor with the full weight of the rack resting on them.
- In a single rack installation, stabilizers should be attached to the rack.
- In multiple rack installations, the racks should be coupled together.
- Always make sure the rack is stable before extending a component from the rack.
- You should extend only one component at a time - extending two or more simultaneously may cause the rack to become unstable.
- Before you install the rails, determine the placement of each component in the rack.
- Install the heaviest components on the bottom of the rack first, and then work up.
- Allow the power supply units to cool before touching them.
- Always keep the rack's trays and card's slots closed when not servicing, to maintain proper cooling.

Installation Precautions



When handling electronic components, standard anti-static precautions must be observed:

- Wear a grounding strap
- Handle cards by their edges only and do not touch their components or connector pins
- Keep components in anti-static bags when not installed in the Collaboration Server (RMX) 1500.

The following precautions should be followed with regards to installation of the Collaboration Server (RMX) 1500:

- Use a regulating uninterruptable power supply (UPS) to protect the Collaboration Server (RMX) 1500 from power surges and voltage spikes, to keep your MCU operating in case of a power failure.
- Place the Collaboration Server (RMX) 1500 on a hard, flat surface such as a desktop or mount it on 19" rack.
- The airflow of the Collaboration Server (RMX) 1500 is from front to back. Be sure that the areas in the front and rear side of the system are clear for proper ventilation.

Installing the RealPresence Collaboration Server (RMX) 1500



Sealed System! The Collaboration Server (RMX) 1500 is a sealed system, breaking the seal and opening the RMX chassis **VOIDS the WARRANTY!**

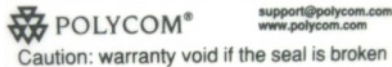

The following procedures have to be performed to install the Collaboration Server (RMX) 1500 in your site:

- Unpacking the RMX
- Installing the RTM ISDN card on the RMX
- Installing the RMX in a rack or as a standalone
- Connecting the RMX to the power source
- Connecting the network (LAN, IP and ISDN) cables to the RMX

Unpacking the RealPresence Collaboration Server (RMX) 1500

Observe the following procedures when unpacking the Collaboration Server (RMX) 1500.

To unpack and lift the Collaboration Server (RMX) 1500:

- 1 When you receive the Collaboration Server (RMX) 1500 packing case, inspect the equipment for damage and verify that the components match the packing slip.
- 2 Open the top cover of the packing case.

Boxes are placed on the top Stratocell® and contain the following:

- *Installation Accessories.* This kit contains the power cables, 3 ethernet cables, USB key and documentation.
- *Rack Installation Accessories.* This kit contains the accessories for the 19" rack.
- *ISDN Package (Optional).* Contains the ISDN card and ISDN Software License.



Write down the RMX's serial number that is on a sticker on the back of the unit. You will need it for product registration later in the process.

- Make sure that boxes contain all the required parts.

Installing the RTM ISDN 1500 Card on the RealPresence Collaboration Server (RMX) 1500

The ISDN card is shipped out of the box and must be manually installed into the rear of the Collaboration Server (RMX) 1500. It is recommended that the ISDN card be installed before the Collaboration Server (RMX) 1500 is placed in a rack.

A *RealPresence® Collaboration Server 1500/1800/2000/4000 Getting Started Guide* Software License is included with the ISDN card and must be registered as part of the Product Registration and Product Activation. For more information, refer to the ISDN Software Licence document you received with your shipment.

For more information on installing the ISDN card, see [Installing or Replacing the RTM ISDN 1500 Card](#).





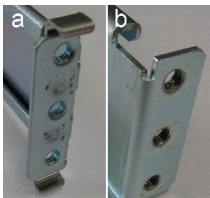

Telescopic Rail Runner Assembly for RealPresence Collaboration Server (RMX) 1500

Before installing the telescopic rail runners in the rack, make sure that the kit has the following parts.

Rail Runners Kit Contents

Part/Kit no.	Item	Item no.	Item Sample	Item Quantity
ASY2716A-L0				
Rail runner	<p>Rail Runner End Views: Left rail runner (two types available: item (a) with or (b) without rail runner clip)</p> <p>Note: The rail runner clip is designed to attach and clip onto the chassis runner frame.</p>	1		1
	<p>Right rail runner (two types available: with or without rail runner clip)</p> <p>Note: The rail runner clip is designed to attach and clip onto the chassis runner frame.</p>	2	See Fig.1-1	1

Rail Runners Kit Contents

Part/Kit no.	Item	Item no.	Item Sample	Item Quantity
Rack spacer assembly kit	Rack spacer	3	Front & Rear 	4
	Flat head screw - M5*10mm	4		8
Rail runner assembly kit	Flat head screw - M3*8mm	5		4
	Flat washer M3	6		4
	Nut spring M3	7		4
RMX chassis assembly kit	Pan head screw - M5*12mm	8		2
	Flat washer M5	9		2

Assembling the Telescopic Rail Runner

Rack Rail Runners require a minimum of 48cm and a maximum of 80cm within the rack for installation.

To assemble the Telescopic Rail Runner:

- 1 Determine the location of the RMX on the rack:
 - Allow for a 1U gap above and below the system for ventilation.
 - Use the **Rack Spacer** (3) to predetermine its position on the rack post, making sure that square studs of the spacer fit into the rack post's square/rounded mounting holes. Mark the spacer's location on the rack post. Repeat this process for the 3 remaining vertical posts ensuring that the system can be horizontally seated.

Front view of RMX Rail Runner Assembly

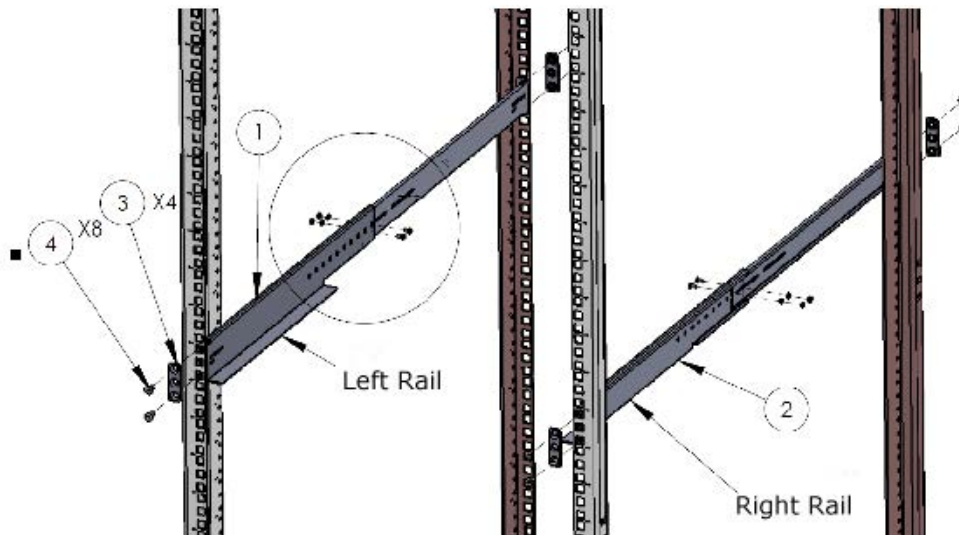

- 2 Position the **Rack Spacer** (3) onto the marked rack post together with left rail runner (1) and fasten the flat head screws 3*10m (4) as shown in the following figure.

Detail of Front Rack Spacer Assembly (left rail runner is shown here) for all RMX types

RMX 1500 rack assembly view without rail runner clip

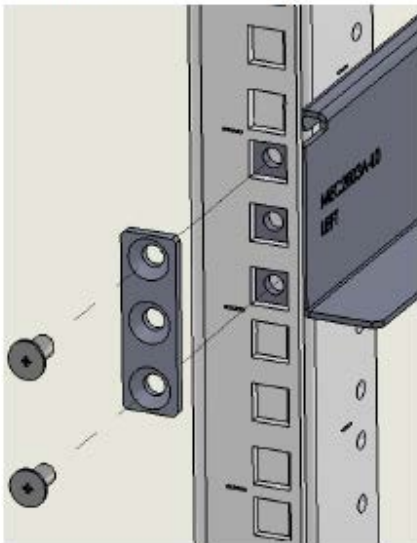

RMX 1500 rack assembly view with rail runner clip

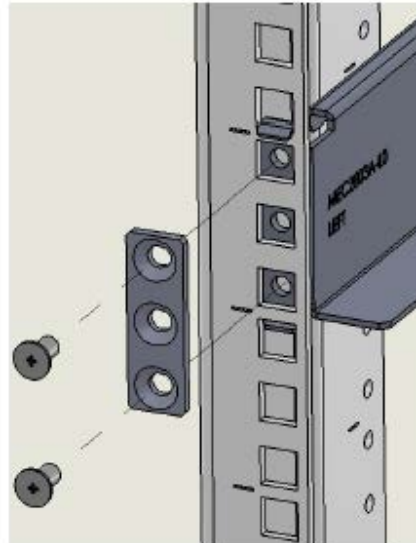



On the RMX1500 the center hole on the *Rack Spacer* must be left clear as it is required for fixing the RMX to the rack post.

- Adjust the telescopic rack rail runner to the rack opening and mount it onto the marked position of the rear post as described in step 2.

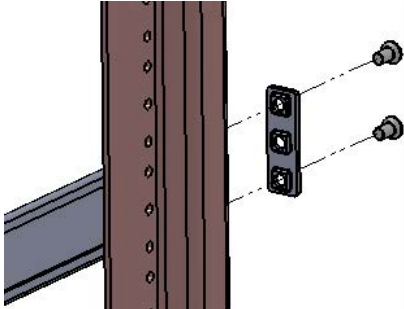
Detail of Rear Collaboration Server (RMX) 1500 Rack Spacer Assembly



- Repeat steps 2 and 3 for the right rack rail runner.

- Install the flat head screw  (item 5), flat washer  (item 6) and nut spring  (item 7) in the middle of the telescopic rack rail runner for added stability, as shown below.

Detail of Left Rail Runner (front internal view)

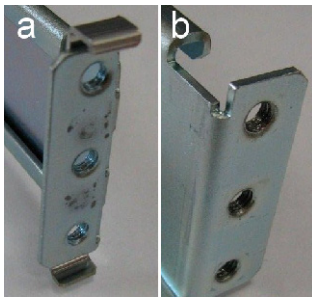

The number of screws to install depends on the rack width.

- Repeat step 5 for the right rack rail runner.

Collaboration Server (RMX) 1500 Bolt Installation

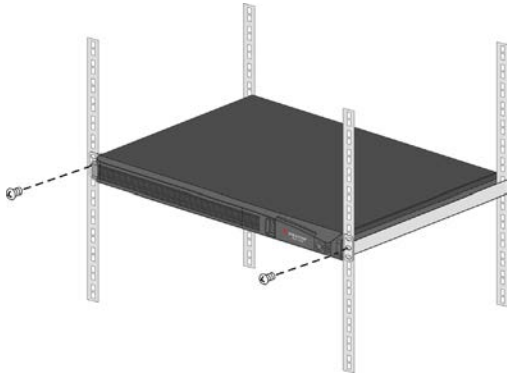

Mounting the RealPresence Collaboration Server (RMX) 1500 on a Shelf

Observe the following procedure to mount the RealPresence Collaboration Server (RMX) 1500 on a shelf.

To mount the RealPresence Collaboration Server (RMX) 1500 on a shelf:

- 1 Install the shelf supplied by the rack manufacturer in the rack.
- 2 Mount the RMX on the shelf.
- 3 Fasten the RMX to the rack with screws through the four holes in the RMX's front mounting brackets.

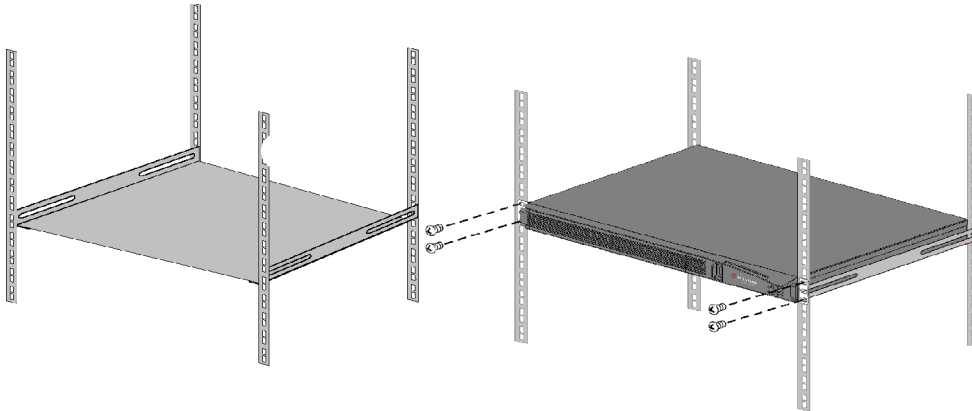

Connecting the RealPresence Collaboration Server (RMX) 1500 to a Power Source

The following restrictions apply to the conductors and connectors that may be used to ground the unit when rack mounted:

- When using bare conductors, they must be coated with an appropriate antioxidant compound before crimp connections are made. Tinned, solder-plated or silver-plated connectors do not have to be prepared in this manner.
- The same bolt assemblies should not secure multiple connectors.

- Listed fastening hardware must be compatible with the materials being joined and must be preclude loosening, deterioration and electrochemical corrosion of the hardware and joint materials.

Connecting the RealPresence Collaboration Server (RMX) 1500 to AC Power



- Do not connect the green or green-yellow wire to the system single-point ground screw.
- Only the AC Power cable supplied by Polycom should be used.
- The size of the protective earthing conductor should be a minimum of 10AWG.
- The outlet intended for connecting the power cord must be protected with an external overcurrent protection device either in building or in the rack with the rating not higher than 20Amp.
- Do not use an extension cord with the cable.

To connect the RealPresence Collaboration Server (RMX) 1500 to AC Power:

- 1 Make sure that the power (push) button is switched **OFF** on the Collaboration Server (RMX) 1500.

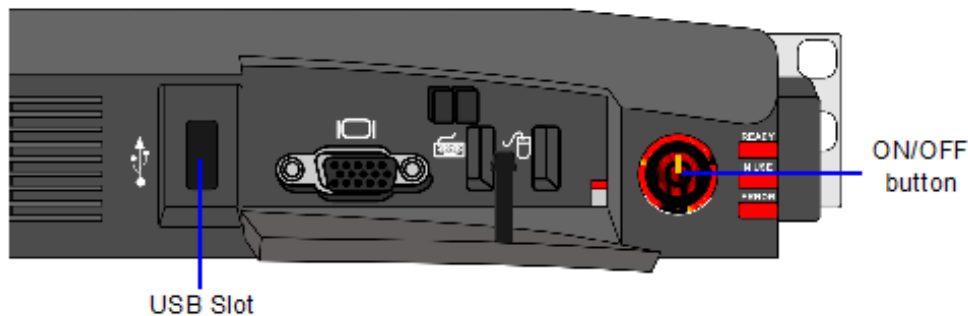

- 2 Insert the power cable into the **Power Connector** on the rear panel of the Collaboration Server (RMX) 1500.

Connecting Cables to the RealPresence Collaboration Server (RMX) 1500

Connect the cables to the RMX 1500 in the order given below.

To connect the cables:

- For the **RTM-IP 1500 module**:
 - **Optional.** Connect the Media cable to **LAN 1** port. This port is used for LAN Redundancy or for Multiple Network Configuration. For more information, see *RealPresence® Collaboration Server (RMX) 1500/1800/2000/4000 Administrator's Guide*, [LAN Redundancy](#) and [Multiple Network Services](#) .
 - Connect the LAN network cable to the **MNGB** (Management Network) port. This port is used for Signaling Redundancy or for Multiple Network Configuration.
 - **Optional.** Connect the LAN signaling cable to the **MNG** (Signaling) port. This port is used for Signaling and Management Redundancy. For more information, see *RealPresence® Collaboration Server (RMX) 1500/1800/2000/4000 Administrator's Guide*, [LAN Redundancy](#) and [Multiple Network Services](#) .
 - **Optional.** Connect the Shelf Management cable to the **Shelf** port.



The LAN 1*, LAN 3, LAN 4 and Modem ports are not to be used and the plastic caps covering those ports should not be removed.

* With Multiple networks and LAN redundancy configurations, LAN 1 port is used. For more information, see *RealPresence® Collaboration Server (RMX) 1500/1800/2000/4000 Administrator's Guide*, [LAN Redundancy](#) and [Multiple Network Services](#) .



When an NTP Server is used for the RMX time, the Shelf Management cable must be connected to the shelf port.

- For the **RTM ISDN 1500 module**:
 - Connect the E1/T1 cables to their **PRI (1-4)** ports.

Collaboration Server (RMX) 1500 Rear Panel View with AC Power and Communication Cables

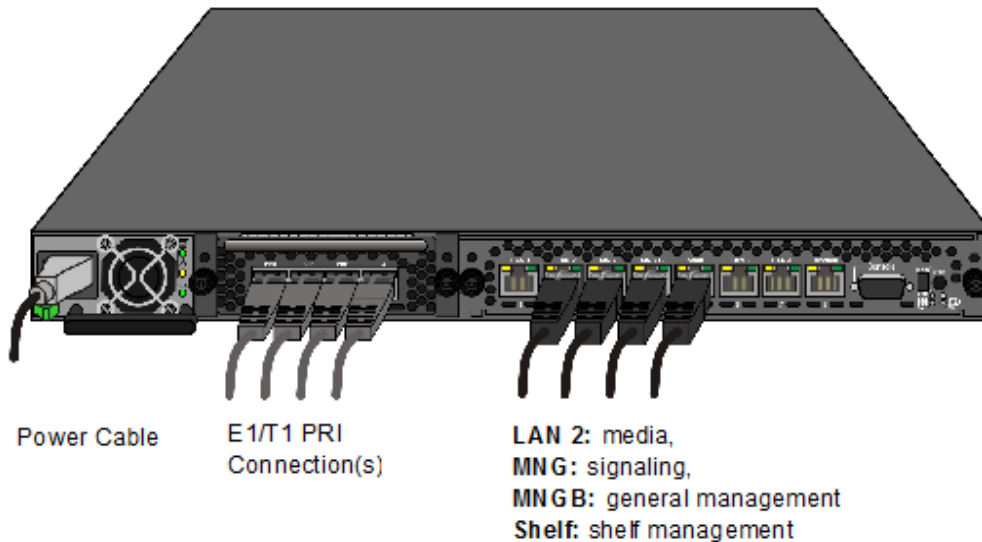

First-time Power-up

Closely observe the following procedure when you switch on the Collaboration Server (RMX) 1500 for the first time.

To power up the RealPresence Collaboration Server (RMX) 1500 for the first time:

- 1 For first entry installation, you must insert the *USB* key containing the modified IP addresses in *USB slot* on the RMX's front panel. For more information see, the *RealPresence® Collaboration Server 1500/1800/2000/4000 Getting Started Guide*, [First-time Power-up](#) .
- 2 Turn ON the power by pressing on the power switch located on the front panel of the Collaboration Server (RMX) 1500.



- You are required to register all Polycom Software Licenses that you have purchased when retrieving the Activation Key. For example, ISDN, Encryption and Network Separation each have different Polycom Software Licenses.
- On the Collaboration Server (RMX) 1500 MPMx-Q assembly, the use of HD with Continuous Presence requires an additional licence.

The parameters in the lan.cfg file are uploaded from the USB key to the RMX's memory and applied during the power-up sequence.

System power-up sequence may take up to five minutes.

During the First-time Power-up the red ERROR LED on the RMX's front panel remains ON until both the Management and IP Network Services have been defined.

When the RMX's configuration is completed (including the Management and IP Network Services), and if there are no System Errors, the green READY LED (on the RMX's front panel) turns ON.

- 3 Remove the USB key. For more information see, the *RealPresence® Collaboration Server 1500/1800/2000/4000 Getting Started Guide*, [Procedure 4: Modifying the Default IP Service and ISDN/PSTN Network Service Settings](#) .

RealPresence Collaboration Server (RMX) 1500 Components

On the Collaboration Server (RMX) 1500 components are located on both the front and rear of the MCU as listed in the following tables: [RealPresence Collaboration Server \(RMX\) 1500 Front Panel Description](#) and [RMX 1500 Rear Panel - RTM IP 1500 Component Description](#) .

RealPresence Collaboration Server (RMX) 1500 Front Panel

The front panel enables access to the RMX 1500 using a USB key, keyboard, mouse and VGA connection.

Opening the Collaboration Server (RMX) 1500 Front Panel

The Collaboration Server (RMX) 1500 has a front panel which can be opened by pressing on the location shown in the following illustration.



Front Panel Components

The components of the front panel are captioned in the following figure.

Collaboration Server (RMX) 1500 Front Panel

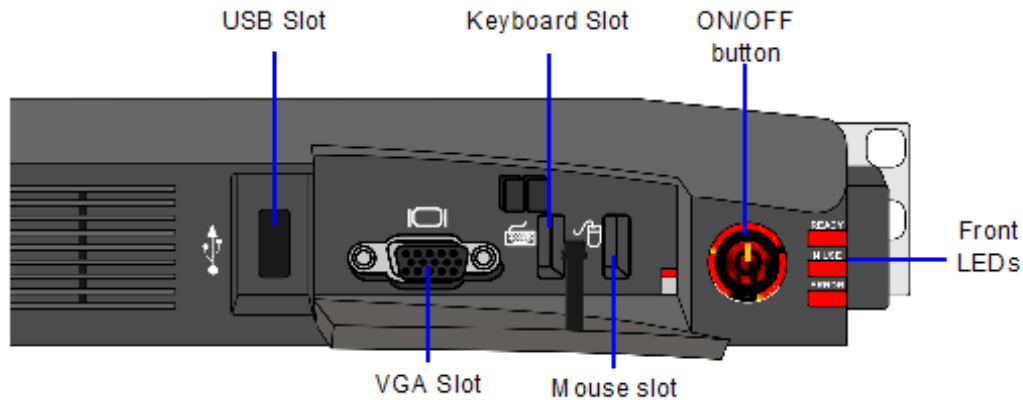

RealPresence Collaboration Server (RMX) 1500 Front Panel Description

SLOT/Button/LED	Description
USB Slot	USB key connection, used for first time configuration.
VGA Slot	Monitor connection.
Keyboard Slot	Keyboard connection.
Mouse Slot	Mouse connection.
ON/OFF Button	Turns the RMX ON or OFF.
READY LED	Orange - RMX Starting up. Green - RMX ready/online.
IN USE LED	Amber - In use, when a conference is active.
ERROR LED	Red - Error.

RealPresence Collaboration Server (RMX) 1500 Rear Panel

The RMX 1500 rear panel contains the RTM IP 1500 and optionally, the RTM ISDN 1500. In addition, the rear panel houses the power supply with fan & AC inlet, and Serial port.

The Collaboration Server (RMX) 1500 rear panel contains the RTM IP 1500 and optionally, the RTM ISDN 1500. In addition, the rear panel houses the power supply with fan & AC inlet, and Serial port.

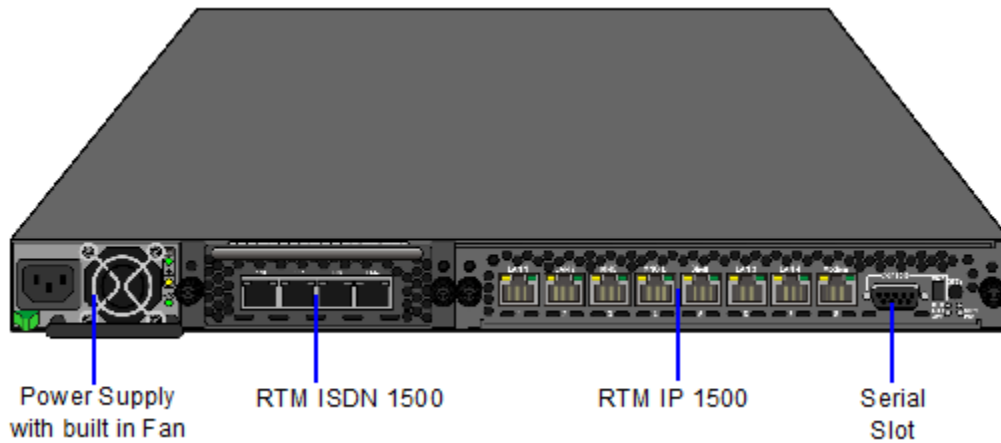

RTM IP 1500

This card contains an Ethernet Switch that manages the network of the system, routes data between the cards and components of the system and provides connectivity to external IP networks. It controls and monitors the system fans and regulates power supply.

The RTM IP 1500 connections include:

- 2 signalling & media ports
- 2 ethernet management ports
- Shelf (Manager) port
- Modem
- 1 Serial port



The LAN 1*, LAN 3, LAN 4 and Modem ports are not to be used and the plastic caps covering those ports should not be removed.

Collaboration Server (RMX) 1500 RTM IP Rear Panel Layout

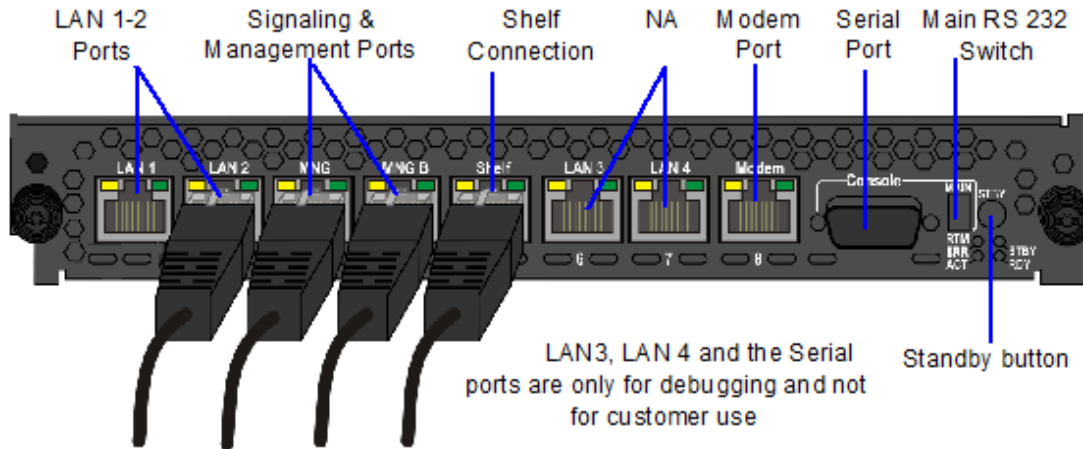

The following items appear on the Collaboration Server (RMX) 1500 rear panel:

RMX 1500 Rear Panel - RTM IP 1500 Component Description

Item	Description
LAN 1 port	Optional. LAN (Media) Connection. With Multiple networks and LAN redundancy configurations, LAN 1 port is used. One Media IP address is available. Always use LAN 2 port if using a single LAN network connection. For more information, see <i>RealPresence® Collaboration Server (RMX) 1500/1800/2000/4000 Administrator's Guide</i> , LAN Redundancy .
LAN 2 port	LAN (Media) connection. One Media IP address is available.
MNG port	Optional. Signaling connection. This port is used for Signaling and Management Redundancy. For more information, see <i>RealPresence® Collaboration Server (RMX) 1500/1800/2000/4000 Administrator's Guide</i> , LAN Redundancy .
MNG B port	Management connection for Web Client and RMX Manager.
LAN 3/4 ports	Not Available (NA). Note: LAN 3/4 are covered with a plastic cap that should not be removed.
Shelf (Manager) port	Optional. Shelf Manager connection.
Modem port	Internal IP connection, for debugging purposes only.
Serial (RS 232) port	For debugging purposes only. Enables print-outs of various LOGs from RTM IP 1500 and Card Manager.

RMX 1500 Rear Panel - RTM IP 1500 Component Description

Item	Description
MAIN/RTM	Selection of the connection type for the RS-232 port. When the switch is up - the serial port connects to the MPMx card. When the switch is down, connects to the RTM IP.
Standby button	Toggle between ON/OFF and standby. Use this button to either perform Diagnostics or Software Recovery on the RMX after turning the system ON. Short press (2 seconds) - MPMx Diagnostics. Long press - (10 seconds) Media and RTM IP 1500 Software Recovery.

RTM ISDN 1500

The ISDN card is shipped out of the box and must be manually installed into the rear of the Collaboration Server (RMX) 1500. For more information, [Installing or Replacing the RTM ISDN 1500 Card](#) .

The RTM ISDN 1500 connects directly to the built-in MPMx. The RTM ISDN card routes data between the MPMx card and components of the system, converts ISDN T1/E1 media to IP packets and provides connectivity to external ISDN networks.

The RTM ISDN card is installed on the rear panel of the RMX interfaces between the RMX unit and the ISDN/PSTN switch.



With the Collaboration Server (RMX) 1500, you can either have a dedicated E1 or T1 Type Network Service. It is not possible to have a mixed E1 and T1 ISDN Network Service.

The RTM ISDN card contains four connections to which up to four E1 or T1 PRI lines can be connected as shown in the figure below.

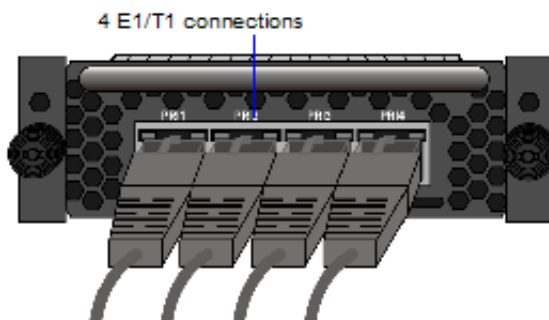
RMX 1500 RTM ISDN Real Panel Layout

The RTM ISDN card supports up to 120 audio participants, regardless of whether the spans are E1 or T1.

ISDN/PSTN Clock Source

Each RTM ISDN 1500 has its own primary and secondary clock source. The first span to synchronize becomes the primary clock source and the second span to synchronize becomes the secondary clock source. This clock is used to synchronize ISDN spans only (it is not the system clock).

A single clock source triggers an alarm that can be turned off by setting the appropriate flag in the system configuration.

RealPresence Collaboration Server (RMX) 1500 Power Supply

Subject to availability on the Collaboration Server (RMX) 1500 there are two types of power supplies (Power-One & Astec), both are identical in their functionality.

RealPresence Collaboration Server (RMX) 1500 LEDs

The RMX includes LEDs located on the front panel and rear panel. In the front panel, the LEDs reflect the state of the components. The LEDs on the rear panel indicate the state of the external connections and the status of the RTM IP card.

RealPresence Collaboration Server (RMX) 1500 Front Panel LEDs

The following items appear on the Collaboration Server (RMX) 1500 front panel:

RMX 1500 Front Panel LEDs

Component	LED ID	LED Color	Indication
Front Panel	ERROR	Red	ON - Major system error. In case of an active alarm this light is ON, and the READY-green is OFF.
			OFF - Normal.
			Flashes - During system startup.
	READY	Green	ON - CPU card has successfully completed startup. This light initially flashes and then turns on green after completing the entire system configuration.
			OFF - Turns OFF when the ERROR red LED is activated.
			Flashes - During system startup.
	IN USE	Amber	ON - At least one endpoint is connected to the system. Flashes - During system startup.

RealPresence Collaboration Server (RMX) 1500 Rear Panel LEDs

RTM IP 1500 LEDs

The following LEDs appear on the RTM IP 1500.

RTM IP 1500 LEDs

Component	LED Name	LED Color	Indication
LAN LEDs (1-2); [(3-4), not in use]	1 Gb	Amber	ON when 1Gb connection is online, flickers with Packet activity.
	LNK	Green	ON with an active network connection, flickers with Packet activity.
MNG LEDs	ACT	Amber	ON with network connection, flickers with Packet activity.
	LNK	Green	ON with a 100Mb online connection. OFF with 1Gb or no connection.
MNG B LEDs	ACT	Amber	ON with network connection, flickers with Packet activity.
	LNK	Green	ON with a 100Mb online connection. OFF with 1Gb or no connection.
Shelf LEDs	LNK	Amber	ON - online connection, flickers with Packet activity. OFF - No Link.
	100	Green	ON - Connection 100Mb. OFF - Connection is not 100Mb or No Link.
Modem	1 Gb	Amber	ON with a 1Gb online connection, flickers with Packet activity.
	LNK	Green	ON with an active network connection, flickers with Packet activity.
Additional LEDs (4)	ERR	Red	ON - Major error on RTM IP 1500. Flashes - During system startup.
	ACT	Amber	ON - Packet flow to and from the MCU chassis. Flashes - During system startup.
	STBY	Green	When the user in the RMX Manager/ RealPresence Collaboration Server Web Client presses the System Shut Down (red) button in the Hardware Monitor tool bar, the system should enter a standby mode and the LED turns ON. Only the media and control unit cards are in a standby mode. Shelf Manager remains active. Turn the system OFF/ON to exit the standby mode.
	RDY	Green	ON - RTM IP 1500 card has successfully completed startup. Flashes - During system startup.

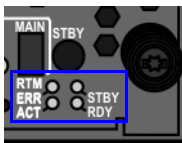

RTM ISDN 1500 LEDs

The following LEDs appear on the RTM ISDN.

RTM ISDN 1500 LEDs

Function Name	LED Color	Indication
PRI (1-4) LEDs	OFF	Span x not in use.
	Green	Span x is OK.
	Red	Span x red alarm (LOS - Loss of Signal)

Power Supply LEDs

The following items appear on the rear panel power supply.

Power Supply LEDs

Component	LED ID	LED Color	Indication
Power Statuses	OK	Green	OK.
	Alarm	Amber	PS Fail - Problem with power supply. This amber LED is driven by internal circuitry and will illuminate when a power rail has failed.
	AC	Green	When the power cable is plugged-in, the AC LED becomes lit.

RealPresence Collaboration Server (RMX) 1500 Component Installation &

Replacement

On the *RealPresence Collaboration Server (RMX) 1500* you can install or replace the RTM ISDN 1500 card.



Only the RTM ISDN is replaceable. The RTM-IP 1500 and Power Supply are not field replaceable.

Before installing or replacing the RTM ISDN make sure:

- you have the correct replacement part on hand.
- you are using proper ESD equipment to prevent damage to the system.



- All maintenance tasks are to be performed by qualified, authorized personnel.
- Use only replacement parts supplied by your dealer.
- Follow all procedures. Do not skip any steps.

Installing or Replacing the RTM ISDN 1500 Card

Prior to adding the RTM ISDN 1500 card you must have your ISDN product license available. For more information see, *RealPresence® Collaboration Server 1500/1800/2000/4000 Getting Started Guide, Procedure 2: Product Registration* .

Removing the Blank Cover or the Existing RTM ISDN 1500 Card from the RealPresence Collaboration Server (RMX) 1500

Carry out the following procedure to remove either the blank cover or the existing card.

To remove the blank cover or the existing RTM ISDN 1500 Card:

- 1 Ensure that the power switch on the RMX is turned **OFF** (O).
- 2 Remove the cover by unscrewing the captive screws that fasten the card to the MCU.
- 3 Slide out the cover.

Installing a New or Replacement RTM ISDN 1500 Card

Carry out the following procedure to install a new card or to replace the existing card.

To install or replace the RTM ISDN 1500 card:

- 1 Slide in the RTM ISDN 1500 card.

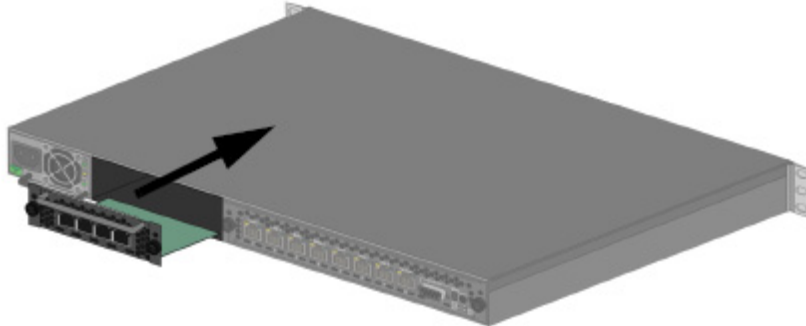

- 2 Insert the card into the slot and tighten the captive screws on each side of the rear panel of the card, securing the RTM ISDN card to RMX.



- 3 Connect the PRI cables.

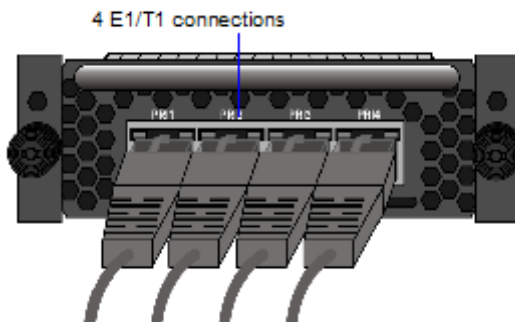

- 4 Turn **ON** the RMX 1500.
- 5 Login on to the RMX Web Client. When a new ISDN card is installed carry out the following procedures:
 - a Update your licence. For more information see, *RealPresence® Collaboration Server 1500/1800/2000/4000 Getting Started Guide*, [Procedure 2: Product Registration](#) .
 - b In the ISDN/PSTN Network Services define a **New ISDN Network Service**. For more information see, *Polycom® RealPresence® Collaboration Server 1500/1800/2000/4000 Administrator's Guide*, [Adding/Modifying ISDN/PSTN Network Services](#) .

PRI Port Assignment

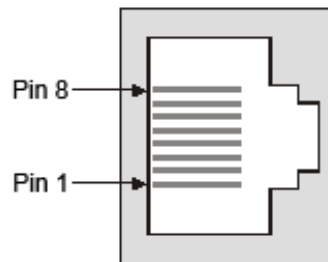

Pin	Signal Name
1	Receive Ring
2	Receive Tip
3	No connection
4	Transmit Ring
5	Transmit Tip
6	No connection
7	No connection
8	No connection