



Hardware Guide

Version 8.3 | May 2014 | 3725-69957-003/B

Polycom® RealPresence® Collaboration Server (RMX) 1800 Hardware Guide



Trademark Information

POLYCOM® and the names and marks associated with Polycom's products are trademarks and/or service marks of Polycom, Inc., and are registered and/or common law marks in the United States and various other countries. All other trademarks are the property of their respective owners.

Patent Information

The accompanying product may be protected by one or more U.S. and foreign patents and/or pending patent applications held by Polycom, Inc.

© 2014 Polycom, Inc. All rights reserved.

Polycom, Inc.
6001 America Center Drive
San Jose CA 95002
USA

No part of this document may be reproduced or transmitted in any form or by any means, electronic or mechanical, for any purpose, without the express written permission of Polycom, Inc. Under the law, reproducing includes translating into another language or format.

As between the parties, Polycom, Inc., retains title to and ownership of all proprietary rights with respect to the software contained within its products. The software is protected by United States copyright laws and international treaty provision. Therefore, you must treat the software like any other copyrighted material (e.g., a book or sound recording).

Every effort has been made to ensure that the information in this manual is accurate. Polycom, Inc., is not responsible for printing or clerical errors. Information in this document is subject to change without notice.

Table of Content

Hardware Description	1
Main Features	1
System Specifications	1
Conferencing Capacities	2
Resource Capacity	3
Resource Capacity in Non-Mixed Conferences	3
Resource Capacities in Mixed Conferences	5
Install the RealPresence Collaboration Server 1800	7
Site Requirements	7
Safety Requirements	7
Shelf Mount Safety Precautions	7
Installation Precautions	8
Install the RealPresence Collaboration Server 1800	8
Mount the RealPresence Collaboration Server 1800 on a Shelf	9
Connect the RealPresence Collaboration Server 1800 to a Power Source	9
Connect the RealPresence Collaboration Server 1800 to AC Power	9
RealPresence Collaboration Server 1800 Front Panel	11
RealPresence Collaboration Server 1800 Rear Panel	12
Regulatory Notices	13
Important Safeguards	13
Remarques importantes concernant la sécurité	13
Regulatory Notices	14
USA and Canadian Regulatory Notices	14
Russia Regulatory Information	15
Customs Union (Russia, Belarus, Kazakhstan) Regulatory Information	15
EU Regulatory Notices	15
Japan	15
Chinese	15
Korea	16

Hardware Description

This Hardware Guide provides information on the RealPresence Collaboration Server 1800 and its components.



Illustrations in this book are for your reference only and may not accurately depict the actual system.

Main Features

The Polycom RealPresence Collaboration Server 1800 offers the following features:

- Linux® based
- Support for standard network ports (H.323, SIP, and LAN)
- New hardware codec technologies
- Up to 1080p 60 high definition video conferencing
- Telecommunication grade high availability and on-line upgrading
- Easy integration of conference elements into external network management
- Enhanced Continuous Presence (multi-image video)
- IVR (Interactive Voice Response) module
- Support both H.264 SVC endpoints-only conferencing, and AVC-SVC mixed conferencing.
- Hot backup to offer high availability and a rapid recovery solution

System Specifications

The following table lists technical specifications of the RealPresence Collaboration Server 1800 1800 system.

Physical	
Height	2U (8.9 cm.)
Width	17.36 " (44.1 cm.)
Depth	19.13 " (48.6 cm.)
Weight	Up to 14.5 Kg (31.97 lbs)

Media Protocols	
Audio	SAV, G.711, G.722.x, G.729A, Siren 14, Siren 22 (in mono or stereo) and Siren LPR.
Video	H.261, H.263, H.263+, H.264, H.264 High Profile, H.264 SVC
Network ports	
IP	H.323, SIP, VoIP
LAN	LAN 1, LAN 2
Power Supply	
AC Input/ Range, Power output	Voltage range: 100-240 VAC 50-60 Hz. Current: 10-3.5 AMP Maximum power output: 740 Watts.
Power Consumption	
AC Maximum Power consumption	350 Watts.
Environment	
Operating temperature	10° to 35°C (50° to 95°F).
Storage temperature	-40° to 70°C (-40° to 158° F).
Relative humidity	20% to 90% non-condensing.
Operating altitude	Up to 5 KM (16404 Ft.)
Operating ESD	4 KV.

Conferencing Capacities

The following table summarizes the different system capacities.

System Functions	Number
Maximum number of Video participants in a conference	150
Maximum number of Audio-only participants in a conference	150
Maximum number of Audio calls per second	5
Maximum number of Video calls per second	2
Maximum number of conferences	200
Maximum number of Meeting Rooms	1000
Maximum number of Entry Queues	40
Maximum number of Profiles	80
Maximum number of Conference Templates	100

System Functions	Number
Maximum number of SIP Factories	40
Maximum number of IP Services	2
Maximum number of IVR Services	80
Maximum number of Recording Links	20 (Default)
Maximum number of IVR Video Slides	150
Maximum number of Log Files (1Mb max.)	4000
Maximum number of CDR Files	2000
Maximum number of Fault Files	1000
Number of Participant alerts	No limitation
Maximum number of concurrent RealPresence Collaboration Server 1800 Web Client connections to the MCU	20
Maximum number Address Book entries	4000
Maximum number of Users	100
Maximum number of Reservations (internal Scheduler)	2000

Resource Capacity

The RMX 1800 system allocates port resources in AVC HD720p30 units. The number of unit ports each type of call requires differs for AVC-SVC mixed conferences and non-mixed conferences.

Listed are the resource capacities for different system configurations, licenses, and conferencing modes.

Resource Capacity in Non-Mixed Conferences

The port consumption of different calls are as shown in this table.

Table: Port consumption of different calls, in non-mixed conferences

720p 30	1080p 60	1080p 30	SD	CIF	Audio	SVC
1	4	2	1/2	1/2	1/2	1/3

In other words, to make a 1080p 60 call, you need four license ports; to make a 1080p 30 call, two license ports; and so forth.

When the required resource is not a whole number, it's rounded up to the nearest whole number. For example, to make an SVC call requiring 1/3 of a license port. In fact, one port will be allocated.

The following table lists the system capacities for each license in non-mixed conferences when the system has one DSP card.

Table: Licensed capacity for systems with three DSP cards, in non-mixed conferences

Licensed ports	1080p 60	1080p 30	AVC HD	AVC SD	AVC CIF	Audio	SVC
5	1	2	5	10	10	10	15
10	2	5	10	20	20	20	30
15	3	7	15	30	30	30	45
20	5	10	20	40	40	40	60
25	6	12	25	50	50	50	75
30	7	15	30	60	60	60	90
35	8	17	35	70	70	70	105
40	10	20	40	80	80	80	120
45	11	22	45	90	90	90	135
50	12	25	50	100	100	100	150
55	13	27	55	110	110	110	165
60	15	30	60	120	120	120	180
65	16	32	65	130	130	130	195
70	17	35	70	140	140	140	210
75	18	37	75	150	150	150	225

The following table lists the system capacities for each license in non-mixed conferences when the system has one DSP card.

Table: Licensed capacity for systems with one DSP card, in non-mixed conferences

Licensed ports	1080p 60	1080p 30	AVC HD	AVC SD	AVC CIF	Audio	SVC
5	1	2	5	10	10	10	15
10	2	5	10	20	20	20	30
15	3	7	15	30	30	30	45
20	5	10	20	40	40	40	60
25	6	12	25	50	50	50	75

Resource Capacities in Mixed Conferences

The port consumption of different calls in mixed conferences are shown in the following table.

Table: Port consumption of different calls, in mixed conferences

720p 30	1080p 30	SD	CIF	Audio	SVC
3/2	3	3/4	3/4	3/4	1/3

In other words, to make a 1080p 30 call, you need three license ports. When the required resource is not a whole number, it's rounded up to the nearest whole number. For example, to make an SVC call requiring 1/3 of a license port. In fact, one port will be allocated.

The following table lists the system capacities for each license in mixed conferences when the system has 3 DSP cards.

Table: Licensed capacity for systems with three DSP cards, in mixed conferences

Licensed ports	1080p 30	AVC HD	AVC SD	AVC CIF	Audio	SVC
5	1	3	6	6	6	15
10	3	6	13	13	13	30
15	5	10	20	20	20	45
20	6	13	26	26	26	60
25	8	16	33	33	33	75
30	10	20	40	40	40	90
35	11	23	46	46	46	105
40	13	26	53	53	53	120
45	15	30	60	60	60	135
50	16	33	66	66	66	150
55	18	36	73	73	73	150
60	20	40	75	75	75	150
65	21	42	75	75	75	150
70	23	42	75	75	75	150
75	25	42	75	75	75	150

The following table lists the system capacities in non-mixed conferences when the system has one DSP card.

Table: Licensed capacity for systems with one DSP card, in mixed conferences

Licensed ports	1080p 30	AVC HD	AVC SD	AVC CIF	Audio	SVC
5	1	3	6	6	6	15
10	3	6	13	13	13	30
15	5	10	20	20	20	45
20	6	13	26	26	26	52
25	8	14	26	26	26	52



Note: About special licenses

For both mixed and non-mixed conferences, special licenses are available to provide up to 100 ports for systems configured with three DSP media cards, or up to 35 ports for systems with one DSP card. For more information, please contact your local Polycom representative.

Install the RealPresence Collaboration Server 1800

This section describes site requirements and system installation procedures.

Site Requirements

This section describes the requirements your site must meet for safe installation and operation of the system.

Safety Requirements

For your protection, please read these safety instructions completely before operating the equipment.

- Look carefully for potential hazards in your work area: moist floors, ungrounded power cables, frayed power cords, missing safety grounds and so forth.
- Locate the main circuit breaker within the room.
- Locate the emergency power **OFF** switch within the room.
- Never assume that power is disconnected from a circuit.
- Use only the power cord supplied with the system.
- The power cord should only be connected to a power outlet that has a protective ground contact.
- Ensure that the power cord is easily accessible from the back of the system at all times.
- Place the equipment in a well-ventilated area where the vents are free from obstruction.
- Do not place heavy objects directly on top of the RealPresence Collaboration Server 1800 unit.
- Do not use liquids around your equipment.

Shelf Mount Safety Precautions

The following precautions should be followed with regards to rack mount safety:



- Keep the area around the RealPresence Collaboration Server 1800 clean and free of clutter.
- Decide on a suitable location for the equipment rack that will hold the RealPresence Collaboration Server 1800 unit. It should be situated in a clean, dust-free area that is well ventilated. Avoid areas where heat, electrical noise and electromagnetic fields are generated. You will also need it placed near a grounded power outlet.
- Ensure that the leveling jacks on the bottom of the rack are fully extended to the floor with the full weight of the rack resting on them.
- Install the heaviest components on the bottom of the rack first, and then work up.
- Allow the power supply units to cool before touching them.

Installation Precautions

	<p>When handling electronic components, standard anti-static precautions must be observed:</p> <ul style="list-style-type: none">• Wear a grounding strap• Keep components in anti-static bags, when not installed in the RealPresence Collaboration Server 1800.
---	--

The following precautions should be followed with regards to installation of the RealPresence Collaboration Server 1800:

- Use a regulating uninterruptable power supply (UPS) to protect the RealPresence Collaboration Server 1800 from power surges and voltage spikes, to keep your MCU operating in case of a power failure.
- Place the RealPresence Collaboration Server 1800 on a hard, flat surface such as a desktop or mount it on 19" rack.
- The airflow of the RealPresence Collaboration Server 1800 is from front to back. Be sure that the areas in the front and rear side of the system are clear for proper ventilation.

	<p>Sealed System! The RealPresence Collaboration Server 1800 is a sealed system, breaking the seal and opening the chassis VOIDS the WARRANTY!</p>	<p> Polycom support@polycom.com www.polycom.com Caution: warranty void if the seal is broken</p>
---	--	--

Install the RealPresence Collaboration Server 1800

The following procedures have to be performed to install the RealPresence Collaboration Server 1800 in your site:

- Unpacking the system
- Installing the system in a rack or as a standalone system
- Connecting the system to the power source
- Connecting the network (*LAN* and *IP*) cables to the system

To unpack and lift the RealPresence Collaboration Server 1800:

- 1 When you receive the RealPresence Collaboration Server 1800 packing case, inspect the equipment for damage and verify that the components match the packing slip.
- 2 Open the top cover of the packing case.
Boxes are placed on the top Stratocell® and contain power cables, 2 ethernet cables, USB key and documentation.

	<p>Write down the system's serial number that is on a sticker on the back of the unit. It will be needed for product registration later in the process.</p>
---	---

Make sure that boxes contain all the required parts.

Mount the RealPresence Collaboration Server 1800 on a Shelf

Follow the steps below to mount the system on a shelf.

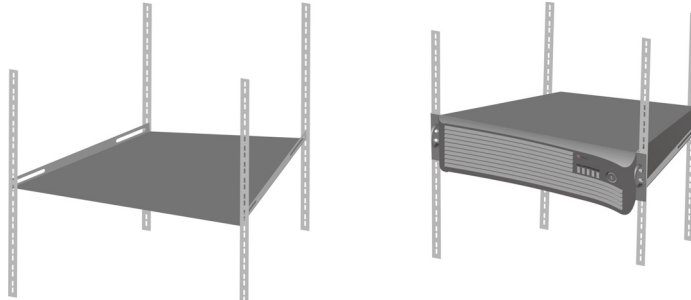

- 1 Install the shelf supplied by the rack manufacturer, in the rack.
- 2 Mount the system on the shelf.
- 3 Fasten the system to the rack with screws through the four holes in the system's front mounting brackets.

Connect the RealPresence Collaboration Server 1800 to a Power Source

The following restrictions apply to the conductors and connectors that may be used to ground the unit when rack mounted:

- When using bare conductors, they must be coated with an appropriate antioxidant compound before crimp connections are made. Tinned, solder-plated or silver-plated connectors do not have to be prepared in this manner.
- The same bolt assemblies should not secure multiple connectors.
- Listed fastening hardware must be compatible with the materials being joined and must be preclude loosening, deterioration and electrochemical corrosion of the hardware and joint materials.

Connect the RealPresence Collaboration Server 1800 to AC Power

	<p>Only the AC Power cable supplied by Polycom should be used. The size of the protective earthing conductor should be a minimum of 10 AWG. The outlet intended for connecting the power cord must be protected with an external overcurrent protection device either in building or in the rack with the rating not higher than 20 AMP. Do not use an extension cord with the cable.</p>
--	---

- » Insert the power cable into the power connector on the rear panel of the RealPresence Collaboration Server 1800 system.

To connect the cables:

- 1 Connect the management network cable to LAN 1 port.

- 2 Connect the media and signaling cable to LAN 2 port.

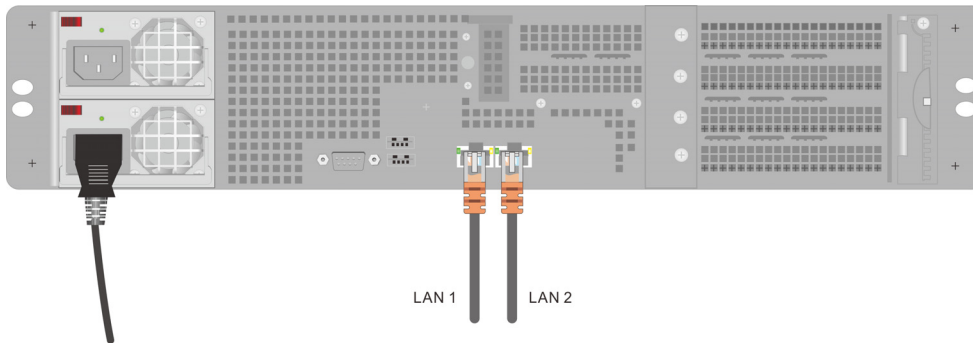

To power up the system for the first time:

- 1 For first entry installation, you must insert the *USB* key containing the modified IP addresses in *USB* slot on the system's back panel. For more information see, the system's *Getting Started Guide*, "Procedure 1: First-time Power-up".
- 2 Turn ON the power by pressing on the ON/OFF button located on the front panel of the RealPresence Collaboration Server 1800.



You are required to register all *Polycom Software Licenses* that you have purchased when retrieving the Activation Key. For example, Encryption and Network Separation each have different Polycom Software Licenses.

The parameters in the *lan.cfg* file are uploaded from the USB key to the system's memory and applied during the power-up sequence.

System power-up sequence may take up to five minutes.

When the system's configuration is completed (including the *Management and IP Network Services*), and if there are no *System Errors*, the STATUS LED (on the system's front panel) turns green.

- 3 Remove the *USB* key. For more information see, the *Getting Started Guide*, "Hardware Description".

RealPresence Collaboration Server 1800 Front Panel

You can power on or off the system, and view the system status from its front panel.

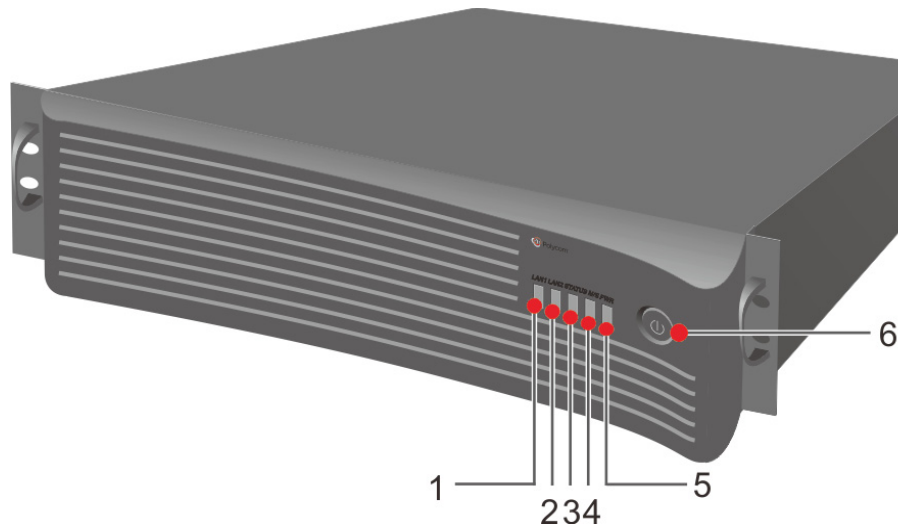

No.	Name	Description
1	LAN 1 LED	Off - No network connection Green - Network connected Flickering green - In use
2	LAN 2 LED	Off - No network connection Green - Network connected Flickering green - In use
3	STATUS LED	Red - System alarms Green - Endpoints are connected to a meeting Flickering green - No system alarms and no endpoints connected to the meeting Flickering blue - Diagnostic tests are running Blue - Diagnostic tests are completed. Remove the USB key (if applicable) and restart the system
4	M/S LED	Blue - System upgrade completed, waiting for reboot Flickering blue - System upgrading in progress Green - The system works normally, either in single mode, or as the master MCU in the hot backup mode Flickering green - The system works normally, as the slave MCU in the hot backup mode
5	PWR LED	Green - Power normal Red - Power alarms
6	ON/OFF button	Power the RealPresence Collaboration Server 1800 System on or off.

RealPresence Collaboration Server 1800 Rear Panel

The RealPresence Collaboration Server 1800 rear panel contains built-in power and fan units, USB, LAN, and serial ports.

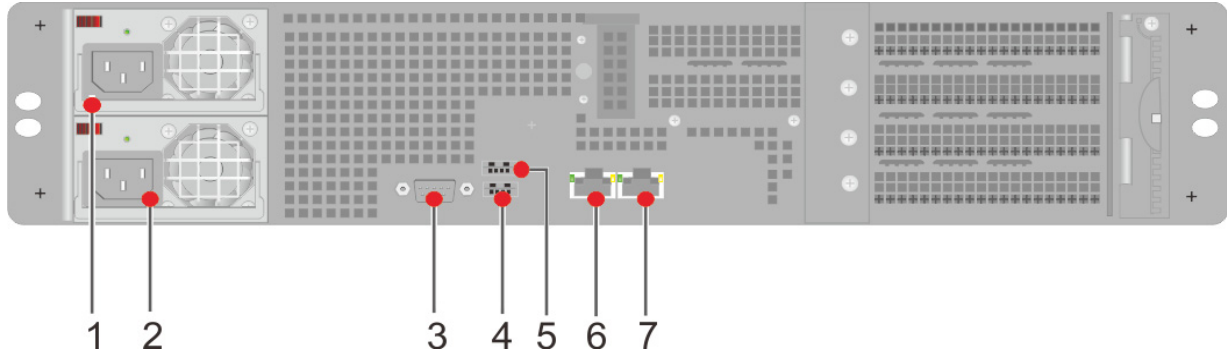

No.	Port	Description
1, 2	Power socket and fan	Built-in power socket and fan
3	Serial (RS 232)	Diagnostics only
4	USB 1	For USB key connection. For more information, see the <i>RealPresence Collaboration Server 1500/1800/2000/4000 Getting Started Guide</i> , “First Time Installation and Configuration”.
5	USB 2	For USB key connection. For more information, see the <i>RealPresence Collaboration Server 1500/1800/2000/4000 Getting Started Guide</i> , “First Time Installation and Configuration”.
6	LAN 1	For management network connection. When LAN redundancy is enabled, LAN 1 is used for both management, media and signaling network connection.
7	LAN 2	For media and signaling network connection. When LAN redundancy is enabled, LAN 2 is the backup of LAN 1 port.

Regulatory Notices

Important Safeguards

Read and understand the following instructions before using the system:

- Close supervision is necessary when the system is used by or near children. Do not leave unattended while in use.
- Only use electrical extension cords with a current rating at least equal to that of the system.
- Always disconnect the system from power before cleaning and servicing and when not in use.
- Do not spray liquids directly onto the system when cleaning. Always apply the liquid first to a static free cloth.
- Do not immerse the system in any liquid or place any liquids on it.
- Do not disassemble this system. To reduce the risk of shock and to maintain the warranty on the system, a qualified technician must perform service or repair work.
- Connect this appliance to a grounded outlet.
- Only connect the system to surge protected power outlets.
- Keep ventilation openings free of any obstructions.
- If the system or any accessories are installed in an enclosed space such as a cabinet, ensure that the air temperature in the enclosure does not exceed 40°C (104° F). You may need to provide forced cooling to keep the equipment within its operating temperature range.
- Do not use this product near water.
- Avoid using this product during an electrical storm. There may be a remote risk of electric shock from lighting.
- Disconnect BOTH power cords to electrically isolate the system, and before removing any covers.
- Note: The appliance inlet can be used as the disconnect device.
- No user serviceable parts are contained within the device.



The device contains a lithium cell. Risk of explosion if battery is incorrectly replaced. Replace only with the same or equivalent type recommended by the manufacture. Dispose of used batteries according to the manufacturer's instructions.

SAVE THESE INSTRUCTIONS.

Remarques importantes concernant la sécurité

Lisez les instructions suivantes et assurez-vous de bien les comprendre avant d'utiliser le système :

- Supervisez attentivement toute utilisation du système par ou près d'enfants. Ne laissez pas le système fonctionner sans surveillance.

- N'utilisez que des rallonges électriques dont le courant nominal est supérieur ou égal à celui du système.
- Débranchez toujours le système de la prise secteur avant de le nettoyer, de le dépanner et lorsque vous ne l'utilisez pas.
- Ne vaporisez pas de liquides directement sur le système lorsque vous le nettoyez. Appliquez toujours le liquide sur un tissu antistatique.
- Ne plongez jamais le système dans un liquide et ne posez jamais de liquide dessus.
- Ne démontez pas le système. Pour réduire tout risque d'électrocution et pour maintenir la garantie du système, les travaux de maintenance et de réparation doivent être effectués par un technicien qualifié.
- Branchez le système à une prise mise à la terre.
- Ne branchez ce système qu'à des prises protégées contre les surtensions.
- N'obstruez pas les orifices de ventilation de l'appareil.
- Si le système ou des accessoires sont installés dans un espace fermé tel qu'une armoire, veillez à ce que la température de l'air ne dépasse pas 40°C (104° F). Pour maintenir la température dans les limites d'utilisation du système, vous pourrez être amené à prévoir un système de refroidissement forcé.
- N'utilisez pas ce produit près de l'eau.
- Évitez d'utiliser ce produit pendant un orage. La foudre pourrait causer des électrocutions, même si le risque est faible.
- Avant de retirer un capot, débranchez les DEUX câbles d'alimentation pour séparer le système de l'alimentation en électricité.
- Remarque : La prise d'entrée de l'appareil peut servir à le débrancher.
- Le système ne contient aucune pièce réparable par l'utilisateur.



L'appareil contient une pile au lithium. Son remplacement par une pile de type incorrect peut entraîner un risque d'explosion. Ne remplacez la pile que par un modèle identique ou équivalent, conformément aux recommandations du fabricant. Mettez les piles usagées au rebut conformément aux instructions du fabricant.

CONSERVEZ CES INSTRUCTIONS.

Regulatory Notices

USA and Canadian Regulatory Notices

This Class [A] digital apparatus complies with Canadian ICES-003.

Cet appareil numérique de la classe [A] est conforme à la norme NMB-003 du Canada.

This device complies with part 15 of the FCC Rules. Operation is subject to the following two conditions: This device may not cause harmful interference, and this device must accept any interference received, including interference that may cause undesired operation.

	<p>This equipment has been tested and found to comply with the limits for a Class A digital device, pursuant to part 15 of the FCC Rules. These limits are designed to provide reasonable protection against harmful interference when the equipment is operated in a commercial environment. This equipment generates, uses, and can radiate radio frequency energy and, if not installed and used in accordance with the instruction manual, may cause harmful interference to radio communications. Operation of this equipment in a residential area is likely to cause harmful interference in which case the user will be required to correct the interference at his own expense. In accordance with part 15 of the FCC rules, the user is cautioned that any changes or modifications not expressly approved by Polycom Inc. could void the user's authority to operate the equipment.</p>
---	--

Russia Regulatory Information

Система	Номер регистрации	Дата истечения срока
RMX 1800	Д-СПД-6669	April 03, 2017

Customs Union (Russia, Belarus, Kazakhstan) Regulatory Information



Система	Номер регистрации	Дата истечения срока
RMX 1800	KZ.7500506.23.01.00068	April 21, 2019

EU Regulatory Notices

This Polycom RMX 1800 system has been marked with the CE mark. This mark indicates compliance with EEC Directives 2006/95/EC and 2004/108/EC. A full copy of the Declaration of Conformity can be obtained from Polycom Ltd, 270 Bath Road, Slough, Berkshire, SL1 4DX, UK.

Japan

この装置は、情報処理装置等電波障害自主規制協議会（VCCI）の基準に基づくクラス A 情報技術装置です。この装置を家庭環境で使用すると電波妨害を引き起こすことがあります。この場合には使用者が適切な対策を講ずるよう要求されることがあります。

Chinese

声明

此为 A 级产品，在生活环境中，该产品可能会造成无线电干扰。在这种情况下，可能需要用户对其干扰采取切实可行的措施。

Korea

A 급 기기 (업무용 정보통신기기)

이 기기는 업무용으로 전자파적합등록을 한 기기이오니
판매자 또는 사용자는 이 점을 주의 하시기 바라며 , 만약
잘못판매 또는 구입하였을 때에는 가정용으로 교환하시기바랍니다 .