



USER GUIDE

3.8.0 | November 2021 | 3725-86558-010A

Poly Video Mode

(G7500, Studio X70, Studio X50, Studio X30 and Studio E70)

Getting Help

For more information about installing, configuring, and administering Poly/Polycom products or services, go to Polycom Support.

Plantronics, Inc. (Poly — formerly Plantronics and Polycom)
345 Encinal Street
Santa Cruz, California
95060

© 2021 Plantronics, Inc. All rights reserved. Poly, the propeller design, and the Poly logo are trademarks of Plantronics, Inc. All other trademarks are the property of their respective owners.

Contents

- Before You Begin.....4**
 - Audience, Purpose, and Required Skills.....4
 - Related Poly and Partner Resources.....4

- Getting Started..... 5**
 - Product Overview of Poly Video Systems.....5
 - Product Overview of Poly Studio E70 Camera..... 7
 - Overview of System Hardware.....8
 - Poly G7500 Hardware.....8
 - Poly Studio X70 Hardware..... 8
 - Poly Studio X50 Hardware..... 10
 - Poly Studio X30 Hardware..... 10
 - Poly Studio X50 and Studio X30 Privacy Cover..... 11
 - Poly Studio E70 Camera Hardware.....11
 - LED Status Indicators..... 13
 - LED Status Indicators for the G7500 System.....13
 - LED Status Indicators for the Studio X70 System.....14
 - LED Status Indicators for Studio X50 and Studio X30 Systems..... 14
 - LED Status Indicators for the Studio E70 Camera..... 15
 - Navigating Your System..... 16
 - Home Screen..... 16
 - Content Screen..... 18
 - Powering the System On and Off.....19
 - Wake the System..... 19
 - Accessibility Features..... 20
 - Users Who Are Deaf or Hard of Hearing.....20
 - Users Who Are Blind, Have Low Vision, or Have Limited Vision..... 20
 - Users with Limited Mobility.....21

- Calling..... 22**
 - Placing Calls..... 22
 - Place a Call..... 22
 - Answer a Call..... 23
 - Ignore a Call..... 23
 - End a Call..... 23
 - Call a Password-Protected Zoom Meeting Using Trio C60..... 23
 - Calling Contacts..... 24

Call a Contact.....	24
Call a Frequent Contact.....	24
Call a Recent Contact.....	24
Calling Favorite Contacts.....	24
Favorite a Contact.....	25
Unfavorite a Contact.....	25
Call a Favorite Contact.....	25
Joining Meetings from the Calendar.....	25
Meeting Cards.....	25
Join an Overbooked Meeting.....	26
Join a Password-Protected Meeting.....	26
Using Device Mode.....	27
Computer and Cable Requirements.....	27
Use Your System as a Computer Accessory.....	27
Exit Device Mode and Disconnect Your Computer.....	28
Sharing Content.....	29
Sharing Content from a Computer or Device.....	29
Polycom Content App.....	29
Cast Content from an AirPlay- or a Miracast-Certified Device.....	29
Share Content Using an HDMI Connection.....	30
Sharing Content on a Blackboard or Whiteboard.....	30
Add a Blackboard or Whiteboard.....	30
Take a Snapshot of Your Content.....	31
Delete Snapshots or Content.....	31
End a Content Session.....	31
End a Call with Blackboard or Whiteboard Content.....	31
Cameras.....	33
Adjust an In-Room Camera.....	33
Adjust a Far-Site Camera.....	33
Turn Your Camera On or Off.....	34
Turn Camera Tracking On or Off.....	34
Using Camera Presets.....	34
Save a Camera Preset from the Local Interface.....	35
Select a Preset.....	35
Delete a Preset.....	35
Selecting the Primary Camera.....	35
Camera Priority.....	36
Select the Primary Camera from the Local Interface.....	36

Using Device Mode.....	37
Computer and Cable Requirements.....	37
Access Device Mode.....	37
Use Your System as a Computer Accessory.....	38
Adjust the System Audio and Camera Settings.....	38
Managing Incoming Calls When in Device Mode	39
Exit Device Mode and Disconnect Your Computer.....	39
Using the Poly Control App.....	40
Control the System with the Poly Control App.....	40
Settings.....	41
Video Adjustments.....	41
Change the Participant Layout.....	41
Audio Adjustments.....	41
Mute Your Microphones.....	41
Unmute Your Microphones.....	42
Adjust the Volume.....	42
Troubleshooting.....	43
Poly Device Mode.....	43
Audio Levels are Too High or Low.....	43
Conferencing Application Doesn't Use System Camera or Audio.....	43
Can't Use System's Camera or Audio.....	43
Improve Audio Quality.....	44
Improve Laptop Screen Mirroring.....	44
Can't Share Wireless Content.....	44
View Content Help Tips.....	45
View Blackboard Help Tips.....	45

Before You Begin

Topics:

- [Audience, Purpose, and Required Skills](#)
- [Related Poly and Partner Resources](#)

This guide contains overview information, procedures, and references you can use to perform tasks with your video system.

The information in this guide applies to all the following Poly video systems except where noted:

- Poly G7500 (model: P011)
- Poly Studio X70 (model: P026)
- Poly Studio X50 (model: P017)
- Poly Studio X30 (model: P018)
- Poly Studio E70 (model: P025)

Audience, Purpose, and Required Skills

This guide is intended for beginning users, as well as intermediate and advanced users, who want to learn more about the features available with the system.

Related Poly and Partner Resources

See the following sites for information related to this product.

- The [Poly Online Support Center](#) is the entry point to online product, service, and solution support information including Video Tutorials, Documents & Software, Knowledge Base, Community Discussions, Poly University, and additional services.
- The [Poly Document Library](#) provides support documentation for active products, services, and solutions. The documentation displays in responsive HTML5 format so that you can easily access and view installation, configuration, or administration content from any online device.
- The [Poly Community](#) provides access to the latest developer and support information. Create an account to access Poly support personnel and participate in developer and support forums. You can find the latest information on hardware, software, and partner solutions topics, share ideas, and solve problems with your colleagues.
- The [Poly Partner Network](#) is a program where resellers, distributors, solutions providers, and unified communications providers deliver high-value business solutions that meet critical customer needs, making it easy for you to communicate face-to-face using the applications and devices you use every day.
- The [Poly Services](#) help your business succeed and get the most out of your investment through the benefits of collaboration.

Getting Started

Topics:

- [Product Overview of Poly Video Systems](#)
- [Product Overview of Poly Studio E70 Camera](#)
- [Overview of System Hardware](#)
- [LED Status Indicators](#)
- [Navigating Your System](#)
- [Powering the System On and Off](#)
- [Wake the System](#)
- [Accessibility Features](#)

Before you use your system, familiarize yourself with its features and local interface.

Note: While you can control the system using the Poly TC8 controller, all tasks in this guide apply to systems using the Bluetooth remote control or a touch-sensitive monitor. For information on using your system with an attached TC8 device, see the [Poly TC8 User Guide](#).

Product Overview of Poly Video Systems

Poly G7500, Studio X70, Studio X50, and Studio X30 systems in Poly Video Mode support Poly video conferencing and content sharing features.

Poly G7500 System Features and Capabilities

G7500 systems support the following features:

- Peripheral cameras and microphones make the system scalable for medium rooms and up to large integrated rooms
- Placing and joining video calls
- Viewing and joining scheduled calendar meetings
- Managing contacts, call lists, and directories
- Sharing wireless and wired content
- Collaborating with electronic blackboards
- Camera tracking technology that can automatically zoom in on the person talking or frame the group of people in the room (depending on the paired camera and system configuration)
- Poly NoiseBlockAI, which eliminates background and extraneous sound during calls in common working environments
- Polycom Acoustic Fence technology, which enables video conferencing in open workspaces by capturing only the voices in a defined area
- HDMI: Single input and dual output
- Serial port connection

- Using a wired or wireless USB mouse as an input device

Poly Studio X70 Features and Capabilities

Studio X70 systems support the following features:

- All-in-one collaboration system for large rooms
- Built-in 4K dual-camera
- Dual stereo speakers
- No need for a separate PC, laptop, or codec to run video-conferencing software
- Camera tracking technology that automatically frames the group of people in the room
- Hi-fidelity, built-in stereo microphones that pick up sound within 7.62 m (25 ft) and use spatial audio for life-like presence and clarity
- Placing and joining video calls
- Viewing and joining scheduled calendar meetings
- Managing contacts, call lists, and directories
- Sharing wireless and wired content
- Collaborating with electronic blackboards
- Poly NoiseBlockAI, which eliminates background and extraneous sound during calls in common working environments
- Polycom Acoustic Fence technology, which enables video conferencing in open workspaces by capturing only the voices in a defined area
- HDMI: Single input and dual output
- Using a wired or wireless USB mouse as an input device

Poly Studio X50 Features and Capabilities

Studio X50 systems support the following features:

- All-in-one collaboration system for huddle rooms and small-to-medium rooms
- No need for a separate PC, laptop, or codec to run video-conferencing software
- Placing and joining video calls
- Viewing and joining scheduled calendar meetings
- Managing contacts, call lists, and directories
- Sharing wireless and wired content
- Collaborating with electronic blackboards
- Built-in 4K camera with ultra-wide 120-degree field of view
- Camera tracking technology that automatically frames the group of people in the room
- Hi-fidelity, built-in stereo microphones that pick up sound within 7.62 m (25 ft) and use spatial audio for life-like presence and clarity
- Poly NoiseBlockAI, which eliminates background and extraneous sound during calls in common working environments
- Polycom Acoustic Fence technology, which enables video conferencing in open workspaces by capturing only the voices in a defined area
- Dual stereo speakers
- HDMI: Single input and dual output

- Using a wired or wireless USB mouse as an input device

Poly Studio X30 Features and Capabilities

Studio X30 systems support the following features:

- All-in-one collaboration system for huddle rooms and small-to-medium rooms
- No need for a separate PC, laptop, or codec to run video-conferencing software
- Placing and joining video calls
- Viewing and joining scheduled calendar meetings
- Managing contacts, call lists, and directories
- Sharing wireless and wired content
- Collaborating with electronic blackboards
- Built-in 4K camera with ultra-wide 120-degree field of view
- Camera tracking technology that automatically frames the group of people in the room
- High-fidelity, built-in stereo microphones that pick up sound within 4.57 m (15 ft) and use spatial audio for life-like presence and clarity
- Poly NoiseBlockAI, which eliminates background and extraneous sound during calls in common working environments
- Polycom Acoustic Fence technology, which enables video conferencing in open workspaces by capturing only the voices in a defined area
- Single mono speaker
- HDMI: Single input and output
- Using a wired or wireless USB mouse as an input device

Product Overview of Poly Studio E70 Camera

Poly Studio E70 is a dual-camera solution supported on Poly G7500 and Studio X50 systems running Poly VideoOS 3.6 or later.

The Poly Studio E70 camera is a standalone USB 4K camera that includes microphones for audio pickup and full tracking and framing capabilities. The Studio E70 camera provides coverage up to 7.6 m (25 ft) for video and audio.

Speaker Framing and Group Framing on Studio E70

Speaker framing enables Studio E70 to determine which participant is actively speaking. The camera then frames the speaker when transmitting video to the far end. Group framing enables the camera to automatically focus on one or more speakers to display all speakers to the far end.

Initially, one camera captures the current view while the other camera uses microphones to voice-track the next target. The camera frames the speaker before displaying the video so that call participants don't see the pan, tilt, or zoom of the cameras. If two people speak alternately, one camera tracks the first speaker while the other camera tracks the second speaker.

Poly Studio E70 Orientation

You can mount the Poly Studio E70 above or below the system display. The Studio E70 camera includes a gyroscopic sensor that automatically detects the camera's orientation.

Overview of System Hardware

The following figures and tables provide information about hardware features available on your system.

Poly G7500 Hardware

The following figure displays the hardware features on the Poly G7500 system. The table lists each feature numbered in the figure.

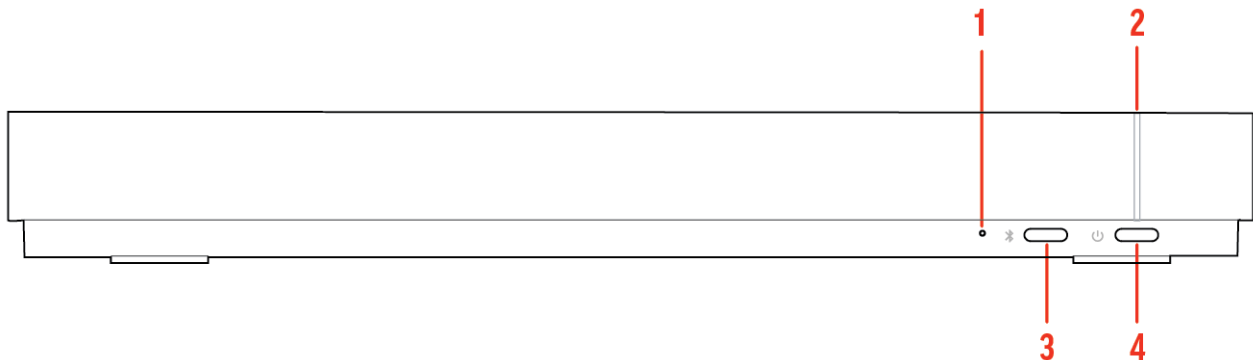

Poly G7500 Feature Descriptions

Ref. Number	Feature	Feature Description
1	Reset button	Resets the Poly G7500 to the factory software version
2	LED indicator	Indicates the system status
3	Remote control pairing button	Enables the Bluetooth remote control pairing mode
4	Restart button	Restarts your system

Poly Studio X70 Hardware

The following figure displays the hardware features on the Poly Studio X70 system. The table lists each feature numbered in the figure.

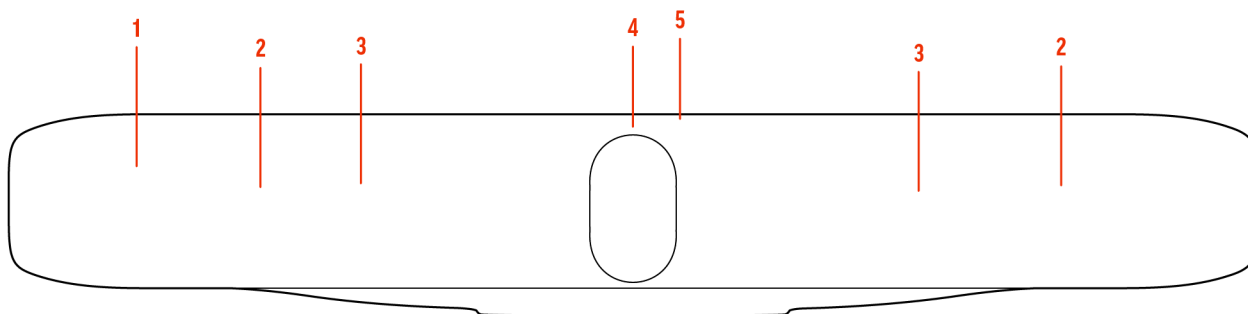

Ref. Number	Feature	Description
1	Screen	Protective screen that covers the front of the system
2	Microphone array	Microphone array that captures audio
3	Speakers	Stereo audio output
4	Dual cameras	Camera array with a privacy shutter that automatically opens or closes, depending on the camera state
5	LED indicators	Indicates the system status and information on the tracked speaker

Poly Studio X70 Privacy Shutter

The privacy shutter on the Studio X70 camera automatically opens and closes depending on the state of the system.

The following table provides the privacy shutter behavior.

Studio X70 Privacy Shutter Behavior

Action	Privacy Shutter Behavior
The system is restarting.	Closed
The system is powered and not asleep or idle.	Open
The system is asleep or idle.	Closed
The system wakes up from being asleep or idle.	Open
The system is in use but not in a call.	Closed
The system is sending video.	Open

Action	Privacy Shutter Behavior
The system receives an incoming call.	Open
The system is in an active video call and the video is unmuted.	Open
The system is in an active video call and the video is muted.	Open

Note: It can take up to 5 minutes for the privacy shutter to close after the system enters into an idle or sleep state.

Poly Studio X50 Hardware

The following figure displays the hardware features on the Poly Studio X50 system. The table lists each feature numbered in the figure.

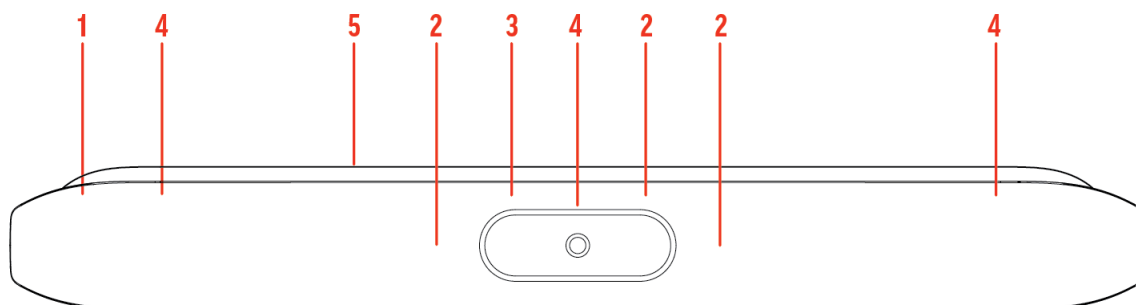

Poly Studio X50 Feature Descriptions

Ref. Number	Feature	Feature Description
1	Screen	Protective screen that covers the front of your system
2	Microphone array	Microphone array that captures audio
3	Camera	Camera with a privacy cover that enables or disables the video input as you choose
4	Speakers	Stereo audio output
5	LED indicators	Indicates the system status and information on the tracked speaker

Poly Studio X30 Hardware

The following figure displays the hardware features on the Poly Studio X30 system. The table lists each feature numbered in the figure.

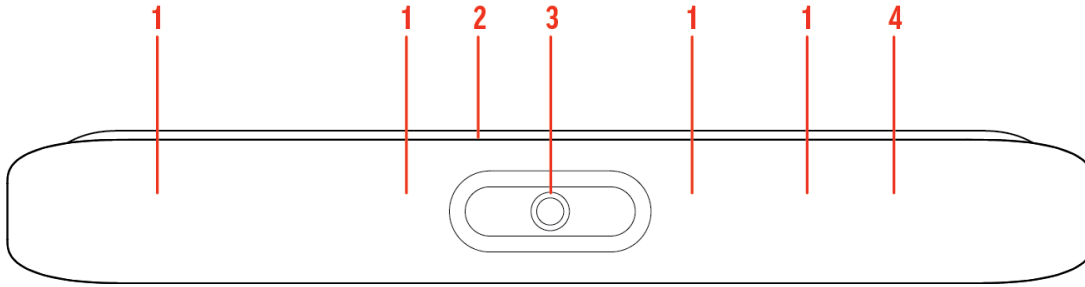

Poly Studio X30 Feature Descriptions

Ref. Number	Feature	Feature Description
1	Microphone array	Microphone array that captures audio
2	LED indicators	Indicates the system status and information on the tracked speaker
3	Camera	Camera with a privacy cover that enables or disables the video input as you choose
4	Speaker	Mono audio output

Poly Studio X50 and Studio X30 Privacy Cover

The Poly Studio X50 and Studio X30 systems provide a physical cover that you can place over the camera lens to protect your privacy.

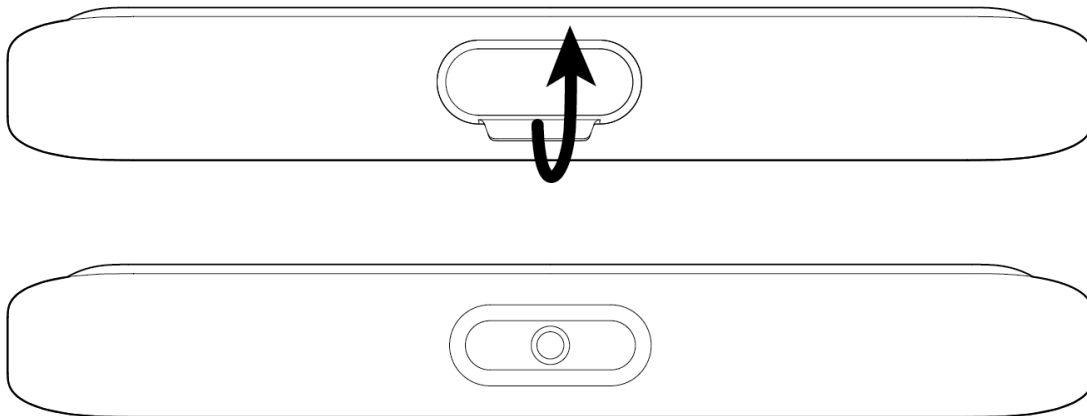

Poly Studio E70 Camera Hardware

The following figure displays the hardware features on the Poly Studio E70 camera. The table lists each feature numbered in the figure.

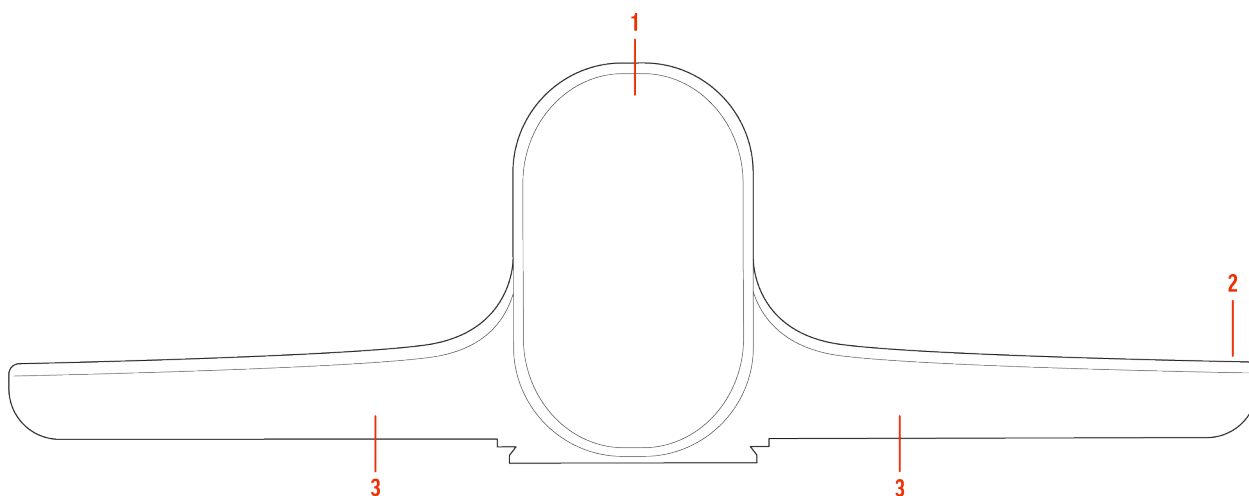

Poly Studio E70 Feature Descriptions

Reference Number	Feature	Description
1	Dual-cameras	Camera array with a privacy shutter that automatically opens or closes depending on the camera state
2	LED indicators	Front and right indicators that show the status of the camera
3	Microphones	Capture audio and track the speaker

Poly Studio E70 Privacy Shutter

The privacy shutter on the Studio E70 camera automatically opens and closes depending on the state of the connected video system.

The following table provides the privacy shutter behavior.

Studio E70 Privacy Shutter Behavior

Action	Privacy Shutter Behavior
The camera is disconnected from the system.	Closed
The camera is connected to the system.	Open
The system is asleep or idle.	Closed
The system wakes up from being asleep or idle.	Open

Action	Privacy Shutter Behavior
The system is in use but not in a call.	Closed
The system is sending video.	Open
The system receives an incoming call.	Open
The system is in an active video call and the video is unmuted.	Open
The system is in an active video call and the video is muted.	Open

Note: It can take up to 5 minutes for the privacy shutter to close after the camera is disconnected from the system or the system enters into an idle or sleep state.

LED Status Indicators

The following figures display the LEDs on your systems. The tables list each LED indicator and its associated status.

LED Status Indicators for the G7500 System

Use the LED on the front right corner of the codec to get information on the state of your system.

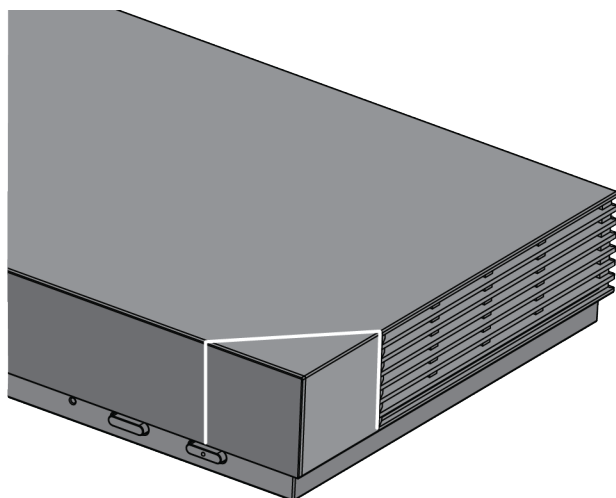

G7500 System LED Status Indicators

Indicator	Status
Blinking white	Powering on
Solid white	Working normally

Indicator	Status
Solid green	In a call
Blinking amber	Update in progress
Solid amber	Sleeping
Blinking red	Error preventing normal operation
Solid red	Muted microphone

LED Status Indicators for the Studio X70 System

Use the LED on the right side of the system to help you understand the system's behaviors.

Basic Studio X70 LED Indicators and Status

Indicator	Status
Solid white	Device is idle and standing by
Pulsing white	Boot initiation in progress
Pulsing amber	Firmware update or factor restore in progress
Blinking blue and white	Bluetooth pairing
Solid blue	Bluetooth paired
Solid green	Active call in progress
Solid red	Audio mute

LED Status Indicators for Studio X50 and Studio X30 Systems

The system provides an LED light bar above the camera to help you understand the system's behaviors.

Basic Studio X50 and Studio X30 LED Indicators and Status

Indicator	Position	Status
Solid white	All	Boot initialization in progress
Blinking blue	Twelve in the middle	Bluetooth in discovery
Solid blue for 3 seconds	All	Bluetooth paired
Blinking green	All	Incoming call
Solid green	All	Outgoing call

Indicator	Position	Status
Solid green	Four to eight (when in the middle), indicating the tracked speaker or the direction of the camera	Working The lights are green with supported applications in the following cases: <ul style="list-style-type: none"> Tracking people in group framing and speaker tracking mode Indicating the direction of the camera that you customize in pan-tilt-zoom (PTZ) mode
Solid amber	Twelve in the middle	Standing by System in sleep mode with no active video output
Pulsing red	Twelve in the middle	Call on hold
Pulsing green	Twelve in the middle	Call on hold (by far site)
Solid white for 3 seconds	Twelve in the middle	Saving a preset
Solid red	All	Muted microphone
Solid red	Four in the middle	Muted camera Muted microphone LEDs take precedence over camera mute LEDs
Pulsing amber	All	Firmware update in progress
Blinking red	All	Error preventing normal operation

LED Status Indicators for the Studio E70 Camera

The camera provides LED indicators on the front and right side of the camera to help you understand the camera's behaviors when connected to a G7500 or a Studio X50 video system.

Studio E70 Camera System LED Status Indicators

Indicator	Status
Solid White (50% brightness)	Powered on but disconnected from video system Sleep
Solid White (100% brightness)	Powered on and connected to the video system
Pulsing white	Boot initialization in progress
Pulsing amber	Firmware update or factory reset in progress

Indicator	Status
Solid green	In a call with the camera and microphone on
Blinking green	Incoming call
Solid red	Video mute (only the right LED is on) Audio mute (both LEDs)
Pulsing red	Held call

Navigating Your System

The system has icons and user screens to help you navigate and understand important information about your system.

Home Screen

The Home screen is the first screen you encounter on the system monitor. From this screen, you have quick access to many of the system functions.

Note: Some elements of your screen may be different depending on the system configuration.

Home Screen

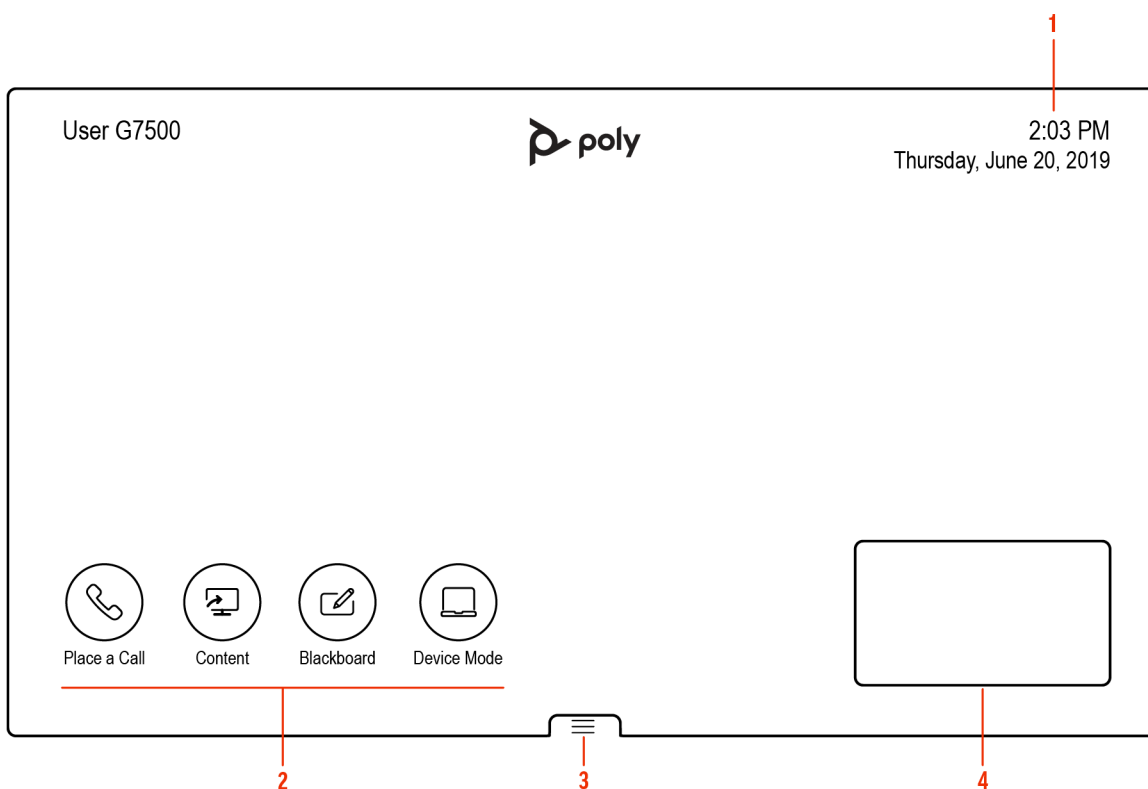







Ref. Number	Description
1	System information bar, which shows details such as date/time and system name.
2	Task buttons for placing calls, sharing content, creating a blackboard, or launching Poly Device Mode.
3	Menu for accessing other features.
4	Local camera view.

Home Screen Elements

Some of the following interactive and read-only elements might not display on your system depending on the system configuration.

Element	Description
Name	Descriptive name determined by the system administrator. Used when you want to connect to a system.
Security code	Displays after you attempt a content sharing connection. Use the four-digit code to set up wireless connections through the Polycom Content App or an AirPlay- or a Miracast-certified device.

Element	Description
IP address	IP address, SIP, H.323, or secondary network configured for your system.
Current time	Local time zone.
Current date	Local time zone date.
Warning 	Notification that the system has detected one or more problems that might prevent it from fully functioning.
Calendar or Favorites cards	View your calendar or favorites.
Place a Call 	Opens a call screen where you can dial a call, or you can select a card to dial numbers, access favorites, or view your calendar.
Content 	When content is available, the system displays a list of available content. Otherwise, this function opens a help screen that describes how to set up content sharing using HDMI, the Polycom Content App, or an AirPlay- or a Miracast-certified device.
Blackboard 	Creates a new blackboard, where you can share annotations or drawings.
Poly Device Mode 	Launches Poly Device Mode, which allows you to use the system as an external camera, microphone, and speaker for your connected laptop.
Menu 	Opens new menu selections for calling, sharing content, camera control, and additional functions.

Content Screen

The Content screen is where you share and annotate content in your meetings.

Content Screen

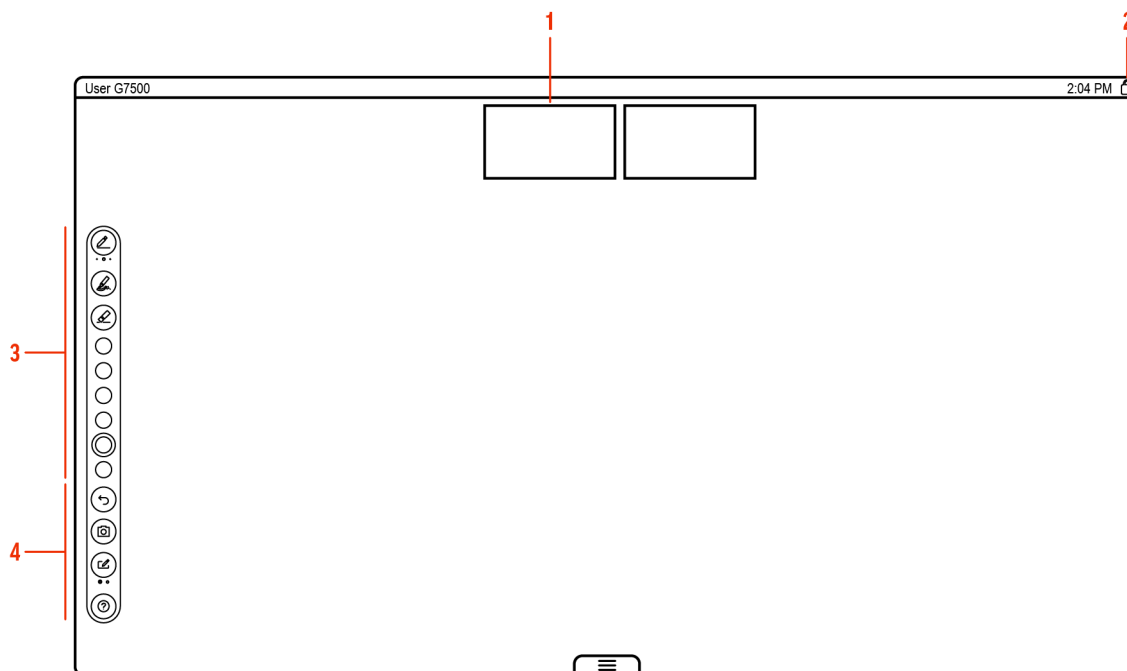

Ref. Number	Description
1	Camera views of call participants.
2	System information bar, shows system information such as system name and time.
3	Content toolbar, provides tools to annotate and work with content.
4	Content management functions.

Powering the System On and Off

The system turns on when you plug it into a power source. The system doesn't have a power button, so you must unplug the power cable to power it off.

Note: Don't power off the system during maintenance activities (for example, while a software update is in progress).

Wake the System

After a period of no activity, the system enters sleep mode (if configured by your administrator). You can wake it using a touch monitor, Poly TC8, or Poly Bluetooth Remote Control.

Procedure

- » Do one of the following:
 - If you're using a touch monitor, tap the primary screen.
 - If you're using the TC8, tap the screen.
 - If you're using a Poly Trio, tap the screen.
 - Press any button on the remote control.

Accessibility Features

Poly products include a number of features to accommodate users with disabilities.

Users Who Are Deaf or Hard of Hearing

Your system includes accessibility features for users who are deaf or hard of hearing to use the system.

The following table lists the accessibility features for users who are deaf or hard of hearing.

Accessibility Features for Users Who Are Deaf or Hard of Hearing

Accessibility Feature	Description
Visual notifications	Status and icon indicators let you know when you have incoming, outgoing, active, or held calls. Indicators also alert you of the device's status and when features are enabled.
Status indicator lights	The system and its microphones use LEDs to indicate some statuses, including if your microphones are muted.
Adjustable call volume	While in a call, you can raise or lower the volume of the device.

Users Who Are Blind, Have Low Vision, or Have Limited Vision

Your system includes accessibility features for users who are blind, have low vision, or have limited vision to use the system.

The following table lists the accessibility features for users who are blind, have low vision, or have limited vision.

Accessibility Features for Users Who Are Blind, Have Low Vision, or Have Limited Vision

Accessibility Feature	Description
Auto-answering	You can enable the phone to auto-answer calls.
Mute auto-answered calls	You can configure the system to mute auto-answered calls.
Ringtones	An audible tone plays for incoming calls.
Join and leave tones	The system plays a tone when someone joins or leaves a conference call.

Accessibility Feature	Description
Embossed buttons	The remote control has embossed push buttons for performing common tasks with the system, such as dialing a number.

Users with Limited Mobility

Your system includes accessibility features to enable users with limited mobility to use various system features.

The following table lists the accessibility features for users with limited mobility.

Accessibility Features for Users with Limited Mobility

Accessibility Feature	Description
Remote control	The Bluetooth remote control enables you to control the system and to perform tasks such as placing calls, starting a sharing session, and configuring some settings.
Poly TC8	The TC8 enables you to control the system and to perform tasks such as placing calls.
Auto-answering	You can enable the system to auto-answer calls.
Calling from a personal device	With administrator credentials, you can wirelessly access the system web interface from your own device to make calls and manage contacts and favorites.
Touch-capable monitor support	If you have a touch-capable monitor connected to the system, you can select, swipe, and press the screen to perform functions and activate features.

Calling

Topics:

- [Placing Calls](#)
- [Calling Contacts](#)
- [Calling Favorite Contacts](#)
- [Joining Meetings from the Calendar](#)
- [Using Device Mode](#)

There are several ways to initiate calls on the system. You can place a call by entering your contact's name or number, choosing a contact in the directory, calling a favorite or recent contact, or joining a scheduled meeting.

You can place calls using the following methods:

- Call using the dialpad
- Call a contact
- Call a frequently used number
- Call a recent contact
- Call a favorite
- Join a meeting from the calendar
- Call using a USB-connected Windows or Mac device

Placing Calls

You can place audio calls, video calls, and call into meetings using the onscreen keyboard.





Use the following dialing formats when placing calls:

- IPv4 address: 192.0.2.0
- Host name: room.company.com
- SIP address: user@domain.com
- H.323 or SIP extension: 2555
- Phone number: 9782992285

Place a Call

You can place an audio or video call to a contact.

Procedure

1. Go to **Place a Call**.
2. On the **Dialpad**  screen, move the slider to **Audio**  or **Video** .
3. Enter a number on the dialpad or select **Keyboard**  to enter characters.

4. Select **Call**.

Answer a Call

The way the system handles incoming calls depends on how your administrator configured it. The system either answers the call automatically or prompts you to answer manually.

Procedure

- » If you receive an incoming call notification, select **Answer**.

Ignore a Call

If the system doesn't answer incoming calls automatically, you can choose to ignore the call rather than answer it.



Procedure

- » If you receive an incoming call notification, select **Ignore**.

End a Call

When your call is complete, hang up the call. If you have content such as blackboards, whiteboards, or snapshots, the system asks if you want to keep them.

Procedure

- » In a call, do one of the following:
 - On your remote control, press **Hang Up** .
 - On the screen, select **Menu**  > **Hang Up**.

Call a Password-Protected Zoom Meeting Using Trio C60

Use these input options when calling into a password-protected Zoom meeting when using Poly Video Mode and a paired Trio C60.

Make sure that you have the meeting password before you join.

Important: If you choose the option to enter the password separately from the dial string, you must enter a pound sign (#) before you enter the password on a Trio C60 system. If you don't enter the pound sign, the call doesn't connect.

Procedure

1. On your Trio C60 controller, select **Dialpad** .
2. Do one of the following:
 - Enter the Zoom Rooms dialing sequence. When the system prompts you for the password, press the pound sign before entering the meeting password.
For example, enter `<meetingID>@zoomcrc.com`, then enter `#<password>`.
 - Enter the Zoom Rooms meeting password as part of the dialing sequence.
For example, enter `<meetingID>.<password>@zoomcrc.com`.

3. Select **Call**.

Calling Contacts

You can access and call contacts, recent contacts, and frequent contacts on your system.

If configured by your administrator, contacts display on the **Place a Call** screen. Contact cards can display the following information:

- Contact name
- Contact number
- Contact email address
- Contact IP address

Call a Contact

To quickly dial a contact, you can search and select a contact card from the results. Contact cards display for frequent contacts, directory contacts, and favorites.

Procedure

1. Go to **Place a Call > Contacts**.
2. In the search field, use the onscreen keyboard to type characters or numbers and select **Search**.
3. Select a contact card to view contact details.
4. Select **Call**.

Call a Frequent Contact

As you place calls, the system learns your frequently-used contacts and displays them in a list.

Procedure

1. Go to **Place a Call**.
2. Select a contact card from the **Frequent** list.
The call automatically dials.

Call a Recent Contact

You can quickly call recent contacts from a list (organized by most to least recent).

Procedure

1. Go to **Place a Call > Recent**.
2. Scroll through the list of recent contacts (sorted by date) and select one.
The call automatically dials.

Calling Favorite Contacts

To quickly access a short list of contacts you call most often, create favorites.

Favorites display on the **Favorites**, **Contacts**, or **Home** screens, depending on your system configuration. The system adds a star icon next to the contact's name, providing you an easy way to identify and call favorites.

Favorite a Contact

Create favorites to display contacts that you call the most often.

Procedure

1. Go to **Place a Call > Contacts**.
2. Select a contact card, then select **Favorite**.

The contact receives a star icon and displays in the **Contacts** and **Favorites** lists.

Unfavorite a Contact

Unfavorite a contact to remove the contact from your **Favorites** list.

Procedure

1. Go to **Place a Call > Favorites**.
2. Choose a favorite card, then select **Unfavorite**.

The contact is removed from the **Favorites** list.

Call a Favorite Contact

To quickly call a contact, select a favorite card.

Procedure

1. Select a favorite card on the **Favorites**, **Contacts**, or **Home** screen.
2. Select **Call**.

Joining Meetings from the Calendar

On the **Home** screen, you can join meetings directly from your calendar using the meeting cards on the screen (if configured).

Note: If calendaring isn't configured for your system, the system doesn't display meeting cards. You must dial manually to join meetings.

Meeting Cards

If configured, meeting cards display on the **Home** screen. You can access meeting cards to view meeting details.

Meeting cards display the following scheduling information:

- All-day meetings display as the first meeting card.
- For meetings scheduled later in the day, a `Free until [time/day]` message displays, followed by upcoming meeting cards in the time and date order they're scheduled.

- For meetings scheduled later in the week, a `Free until [time/day]` message displays until the day of the next scheduled meeting.
- If there are no scheduled meetings for the current week, a `No Meetings` message displays.

View Meeting Cards

On the **Home** screen, you can view meeting cards that show your calendar event details. Meeting cards display meeting times, subjects, and organizers.

Note: Private meetings are labeled **Private Meeting**. Except for the time, meeting details are hidden.

Procedure

- » Do one of the following:
 - To view meeting information, choose a meeting card and select **Info**.
 - To view upcoming scheduled meetings, select a card and scroll to the right.

Join a Meeting from a Meeting Card

On the **Home** screen, you can select a meeting card for options to join a meeting.

The system supports automatic dialing if the meeting organizer added calling information to the calendar event and your administrator has configured calendaring.

Procedure

- » Do one of the following:
 - On a current meeting card, select **Join**.
 - If the meeting card doesn't include calling information, select **More ...**the card to display the dialpad. Dial the number to join the meeting.

Join an Overbooked Meeting

If two or more meetings are scheduled at the same time, the meetings display as **Overbooked**. You can join one of the meetings using its individual meeting card.

Procedure

1. Select an overbooked meeting card and choose **Info**.
The individual meeting cards display.
2. Choose one of the meeting cards and select **Join** to connect to the meeting.

Join a Password-Protected Meeting

Some meetings may require a password to join.

Make sure that you have the password for password-protected meetings before you join. If you don't have a meeting password and a message prompts you for one, contact the meeting organizer for the password.

Note: Meeting cards don't indicate if a meeting is password protected.

Procedure

1. Do one of the following:
 - Manually dial in to a meeting.
 - Join a meeting from a meeting card.
2. Enter the meeting password and select **Join**.
If you enter an incorrect password, the password prompt displays again.

Using Device Mode

Poly Device Mode enables you to use the system's camera, speaker, microphone, and connected monitors from your computer.

Once you connect the system to your computer with a USB cable, you can control the video system's camera and audio features using your computer's third-party conferencing application. For example, instead of using your computer's camera for Zoom Rooms calls, connect the Studio X30 and use its 4K camera to automatically follow the conversation in the room. You also gain a Poly echo-cancelling microphone and speaker technology during calls.

Note: Studio X70 doesn't support Device Mode.

Computer and Cable Requirements

Your computer and cables must meet the following requirements to use Device Mode.

Operating system requirements:

- Windows 10 1803 or later
- macOS 10.12 or later

USB cable requirements:

- A cable with at least one USB-C connection for the video system
- USB 2.0 or USB 3.0 cable (preferred to ensure connection reliability and video and audio quality)
- Self-powered USB booster extension cable for connections longer than 2 m (6.6 ft)

Note: Don't use a cable used for charging devices. A charging cable may not be capable of sending data.

HDMI cable requirements:

- An HDMI adapter is required if your computer doesn't have an HDMI port

Use Your System as a Computer Accessory

To use the video system as an external camera and audio accessory, set your system to Device Mode and connect your Windows or macOS computer with a USB cable.

If your system isn't already in Device Mode, access **Device Mode**. If your conferencing application uses echo cancellation, disable that feature.

You must use a cable with at least one USB-C connection for your video system. If you use a cable with only one USB-C connection, the USB-C end must connect to your video system for Device Mode to work properly.

Note: Device Mode isn't available if your system administrator disables the system USB ports. If you need help with Device Mode or connecting a computer to your system, contact your administrator.

Procedure

1. Connect a USB-C end of the USB cable to the video system's USB-C port, and connect the other end of the USB cable to your computer.

The system monitor and the TC8 device display a confirmation message.

2. Optional: To display your computer on the video system monitor, connect your computer using the system's HDMI input port.

Related Links

[Access Device Mode](#) on page 37

[Share Content Using an HDMI Connection](#) on page 30

Exit Device Mode and Disconnect Your Computer

Any camera options you change on the video system with your USB-connected computer revert to their previous settings when you exit Device Mode.

Note: If the system is using Device Mode as the provider, **Exit** (⊗) isn't available.

Procedure

- » Do one of the following:
 - On the video system local interface or TC8 device (if you've one), select **Exit** (⊗).
 - Unplug the cables connecting your computer and video system. After 2 minutes, you see the home screen (even if you haven't selected **Exit**).

Sharing Content

Topics:

- [Sharing Content from a Computer or Device](#)
- [Sharing Content on a Blackboard or Whiteboard](#)
- [End a Content Session](#)
- [End a Call with Blackboard or Whiteboard Content](#)

To enhance the collaboration experience, you can share documents, graphics, videos, and blackboards or whiteboards with other participants.

You can share content with all members of a call or meeting using a computer or a certified device.

Sharing Content from a Computer or Device

You can share content from a computer or use applications to stream content from other devices.

You can use the following methods to share content:

- Polycom Content App, which wirelessly connects to the system
- Screen mirroring with an AirPlay- or Miracast-certified device
- Computer or device directly connected to the system through HDMI

The system allows up to four simultaneous content sources out of a call and three in a call (a source can include content shared from a device in the room or by a far-end participant).

For example, if you're in a call with three content sources and you share your desktop using the Content App, the oldest wireless or far-end content source in the session is replaced by your content. HDMI content, however, is never replaced.

Important: Before you share content, take precautions to protect your privacy. For example, disable your device's screen lock feature before you share your screen with meeting participants.

Polycom Content App

The Polycom Content App enables you to share content from a computer connected to a system over an IP network.

For information on using this application, see the [Polycom Content App User Guide](#).

Cast Content from an AirPlay- or a Miracast-Certified Device

You can share content from your Airplay- or Miracast-certified device and display it on the system.

Procedure

1. Go to AirPlay or Miracast on your device.
2. From the list of available devices, select the name of your system.

3. Begin casting from your AirPlay- or Miracast-certified device.
For casting information for your device, refer to the product documentation.
4. If prompted, enter the security code shown on the **Home** screen.

Share Content Using an HDMI Connection

Share content from your device through an HDMI connection. This method doesn't require you to connect using a wireless service.

Procedure

- » Connect your device to the video system's HDMI input port.
Your HDMI content displays until you disconnect your device. If you restart the video system while your device is connected, the HDMI content is still there following the reboot.

Related Links

[Use Your System as a Computer Accessory](#) on page 27

Sharing Content on a Blackboard or Whiteboard

Blackboards and whiteboards provide blank canvases to write on so you can share your ideas and collaborate with others.

Note: The **Blackboard**  button only displays if a mouse or touchscreen is connected to the system.







Add a Blackboard or Whiteboard

You can create a blackboard or whiteboard at any time.

Note: If the active board has no annotations, you can't add a new board.

A limited number of blackboards or whiteboards are available. A prompt notifies you when you have reached the limit.

Procedure

1. Do one of the following:
 - Out of a call: On the Home screen, select **Blackboard** .
 - In a call: Select **Menu**  > **Content** > **Blackboard** .
2. To add another board, do one of the following:
 - To add a blackboard: In the toolbar, select **Blackboard** .
 - To add a whiteboard: In the toolbar, long press **Blackboard**  and select **Whiteboard** .

Note: The default board type is whatever type you last selected.

Take a Snapshot of Your Content

You can take a picture of your current content. Then you can annotate on the snapshot or download it using the Polycom Content App.

A limited number of snapshots are available. A prompt notifies you when you have reached the snapshot limit.

Procedure

- » With a board or content on the screen, select **Snapshot** .

The system captures the content and displays it as **Snapshot-1**. The system names additional snapshots with successive numbers.

Delete Snapshots or Content

You can delete snapshots or content that you no longer need.

Procedure

1. Select a snapshot or piece of content in the content tray.
2. Select the red **X**.
3. Select **Delete**.

End a Content Session

By ending the content session, you stop showing and delete all content shared on your system.

Procedure

1. During a content session, select **Menu**  > **End Session**.

A message displays a warning and a countdown timer.

2. Select **End Session**.

Note: To keep content, select **Continue Session**.

End a Call with Blackboard or Whiteboard Content

If there's an open blackboard or whiteboard in your call (including drawings, markup, snapshots, or even a blank board), you can keep that content session going after hanging up. (Markup doesn't include highlights.)

Procedure

1. In a call with blackboard or whiteboard content, select **Menu**  > **Hang Up** .

The call ends and the system prompts if you want to keep content.

2. Do one of the following:
 - Select **Yes, Keep Content**.
 - Select **No, End Session**.

If you keep content, the content session continues.

3. When you are ready to stop content, select **Menu** ≡ > **End Session** > **End Session**.

Cameras

Topics:

- [Adjust an In-Room Camera](#)
- [Adjust a Far-Site Camera](#)
- [Turn Your Camera On or Off](#)
- [Turn Camera Tracking On or Off](#)
- [Using Camera Presets](#)
- [Selecting the Primary Camera](#)

Camera controls are available in and out of calls.

You can control cameras, depending on the camera type, in the following ways:

- Adjust an in-room camera
- Adjust a far-site camera
- Turn your camera on or off
- Turn camera tracking on or off
- Select, save, or delete presets





Adjust an In-Room Camera

To enhance the view of meeting participants, make adjustments to the in-room camera.

If camera tracking is on, camera control is unavailable. Turn tracking off to access camera controls.

With the Studio X50 and Studio X30 systems, you can't pan or tilt the camera if it's zoomed all the way out.

Procedure

1. Select **Menu**  > **Camera** .
2. Select **Control** .
3. Press **+** to zoom in or **-** to zoom out. Press the arrows to tilt up and down or to pan left to right.
4. To exit the control screen, select **Back** .





Adjust a Far-Site Camera

To enhance your view of the other meeting participants during a call, you can adjust the far-site camera.

If camera tracking is on, camera control is unavailable. Turn tracking off to access camera controls.

Note: Contact your administrator for help setting up this feature.

Procedure





1. Select **Menu**  > **Camera** .
2. Select **Control** .
3. Select **Switch**  to select the **Far** camera.
4. Press **+** to zoom in or **-** to zoom out. Press the arrows to tilt up and down or to pan left to right.
5. To exit the control screen, select **Back** .

Turn Your Camera On or Off

Turn your camera on to show local video or turn your camera off to hide your local video.

Note: Turning the camera on or off doesn't control the privacy shutter for the Studio E70 camera. When you turn the camera off, the Studio E70 camera stops sending video, but the privacy shutter remains open. See [Poly Studio E70 Privacy Shutter](#) on page 12 for more information on the privacy shutter behavior.

Procedure

1. Go to **Menu**  > **Camera** .
2. Do one of the following:
 - Select **Camera On** .
 - Select **Camera Off** .

Turn Camera Tracking On or Off

When camera tracking is on, the camera automatically frames the group of people in the room or the current speaker (depending on your camera and how your system is configured).

Note: If you mute your local microphone, the system disables speaker tracking.

Procedure

1. Select **Menu**  > **Camera** .
2. Select **Tracking On**  or **Tracking Off** .

Using Camera Presets

If your camera supports presets, you can save up to 10 camera positions. Camera presets are stored camera positions that let you quickly point a camera at predefined locations in a room.

Near camera presets are available in or out of a call. Far camera presets are only available during a call. If enabled, you can use them to control the far-site camera.

When you save a preset, the preset saves the selected camera and the camera position.

Note: If camera tracking is on, camera controls and presets are unavailable. Turn tracking off to access these features.

Save a Camera Preset from the Local Interface

Save the current camera position as a preset for later use.

Use saved presets to change the near camera position in or out of a call. Far camera presets are available only in a call.

Procedure

1. Select **Menu** ≡ > **Camera** □.
2. Select **Presets**.
3. Adjust the camera to the desired position.
4. Do one of the following:
 - On the screen, select an empty preset.
 - On the screen, long press the preset and choose **Save**.
 - On the remote control, press a number to select a preset.

Select a Preset

Using previously created camera presets, you can quickly move the camera to a desired position in a call.

Procedure

1. Select **Menu** ≡ > **Camera** □.
2. Select **Presets**.
3. Do one of the following:
 - Select the image of the preset you want.
 - On the screen, long press the image and choose **Select**.
 - On the remote control, press a number to select a preset.

Delete a Preset

You can delete a camera preset that you no longer need.

Procedure

1. Select **Menu** ≡ > **Camera** ■.
2. Select **Presets**.
3. On the screen, long press the preset image you want to delete.
4. Select **Delete** 🗑️.

Selecting the Primary Camera

In Poly Video Mode and Zoom Rooms, if you have more than one camera attached to the system, you can select the primary camera in or out of a call.

Camera Priority

When you connect or disconnect a camera, camera priority determines the primary or active camera.

- When you attach a camera to a system that's powered on, it automatically becomes the current people camera.
- If you attach a camera during a call, it automatically becomes the current people camera.
- If you disconnect the current people camera, the system falls back to the next priority camera.

The system observes the following camera type priority:

1. Embedded camera
2. HDCI camera
3. USB camera
4. HDMI source set to display as people

Select the Primary Camera from the Local Interface

In Poly Video Mode, when you attach multiple cameras to the system, select the primary camera from the local interface.

Procedure

1. Go to **Menu > Camera > Select Camera**.
2. Select a camera from the list.

The selected camera becomes the primary camera.

Using Device Mode

Topics:

- [Computer and Cable Requirements](#)
- [Access Device Mode](#)
- [Use Your System as a Computer Accessory](#)
- [Adjust the System Audio and Camera Settings](#)
- [Managing Incoming Calls When in Device Mode](#)
- [Exit Device Mode and Disconnect Your Computer](#)

Poly Device Mode enables you to use the system's camera, speaker, microphone, and connected monitors from your computer.

Once you connect the system to your computer with a USB cable, you can control the video system's camera and audio features using your computer's third-party conferencing application. For example, instead of using your computer's camera for Zoom Rooms calls, connect the Studio X30 and use its 4K camera to automatically follow the conversation in the room. You also gain a Poly echo-cancelling microphone and speaker technology during calls.

Note: Studio X70 doesn't support Device Mode.

Computer and Cable Requirements

Your computer and cables must meet the following requirements to use Device Mode.

Operating system requirements:

- Windows 10 1803 or later
- macOS 10.12 or later

USB cable requirements:

- A cable with at least one USB-C connection for the video system
- USB 2.0 or USB 3.0 cable (preferred to ensure connection reliability and video and audio quality)
- Self-powered USB booster extension cable for connections longer than 2 m (6.6 ft)

Note: Don't use a cable used for charging devices. A charging cable may not be capable of sending data.

HDMI cable requirements:



- An HDMI adapter is required if your computer doesn't have an HDMI port

Access Device Mode

Use the system touchscreen or a TC8 device to start Device Mode.

Note: Your administrator may configure your system to remain in Device Mode. If your system is already in Device Mode, the system monitor and TC8 device prompt you to connect a USB and HDMI cable to your computer.

Procedure

- » Do one of the following:
 - On a TC8 or touchscreen monitor, select **Device Mode** .
 - On a Trio phone, use the phone's navigation keys to highlight **Device Mode** , then press the **Select** button.

The **Device Mode** screen appears.

Related Links

[Use Your System as a Computer Accessory](#) on page 27

Use Your System as a Computer Accessory

To use the video system as an external camera and audio accessory, set your system to Device Mode and connect your Windows or macOS computer with a USB cable.

If your system isn't already in Device Mode, access **Device Mode**. If your conferencing application uses echo cancellation, disable that feature.

You must use a cable with at least one USB-C connection for your video system. If you use a cable with only one USB-C connection, the USB-C end must connect to your video system for Device Mode to work properly.

Note: Device Mode isn't available if your system administrator disables the system USB ports. If you need help with Device Mode or connecting a computer to your system, contact your administrator.

Procedure

1. Connect a USB-C end of the USB cable to the video system's USB-C port, and connect the other end of the USB cable to your computer.
The system monitor and the TC8 device display a confirmation message.
2. Optional: To display your computer on the video system monitor, connect your computer using the system's HDMI input port.

Related Links

[Access Device Mode](#) on page 37

[Share Content Using an HDMI Connection](#) on page 30

Adjust the System Audio and Camera Settings

In Device Mode, you can mute the system, adjust the volume, and adjust camera settings.

Access **Device Mode** and connect your computer to the system.

Note: The controls on a connected Poly Trio phone don't work if the system is in Device Mode.

Procedure

1. To mute the microphones, do one of the following:
 - In a conference application on your computer, select **mute**.
 - On the TC8 or any connected microphone, select **Mute** .
2. To adjust the volume, do one of the following:
 - On the touchscreen or TC8, select **Volume** and adjust the volume slider.
 - Adjust the volume from your computer using the computer or conference application settings.

Note: Ensure that you select the correct device when adjusting the volume. Changing the volume alone may not work. You must have selected the Poly video system as the audio device.

3. To configure camera settings:
 - a. From the right border of the TC8 or the touchscreen, swipe left and select **Camera Settings**.
 - b. Select **Camera Control**.
 - Turn **Camera Tracking** on or off.
 - Select or set a **Preset**.
 - Press **+** to zoom in or **-** to zoom out.
 - Press the arrows to tilt up and down or to pan left to right.

Managing Incoming Calls When in Device Mode

Your video system rejects incoming calls in Device Mode.

Exit Device Mode and Disconnect Your Computer

Any camera options you change on the video system with your USB-connected computer revert to their previous settings when you exit Device Mode.

Note: If the system is using Device Mode as the provider, **Exit**  isn't available.

Procedure

- » Do one of the following:
 - On the video system local interface or TC8 device (if you've one), select **Exit** .
 - Unplug the cables connecting your computer and video system. After 2 minutes, you see the home screen (even if you haven't selected **Exit**).

Using the Poly Control App

Topics:

- [Control the System with the Poly Control App](#)

The Poly Control App enables you to control a video system using a personal device, such as your mobile device or computer.

After you connect your personal device to the video system, you can place and manage calls, control camera settings, and interact with shared content.

The following features aren't available on the computer or mobile device controlling the system:

- Device mode
- Environment
- System settings (only system information displays)

Control the System with the Poly Control App

You can use the Poly Control App on your computer or mobile device to control a video system.

You must be in the room with the video system and connect the mobile device to the same wireless network as the system to use the Poly Control App.

Procedure

1. In a web browser on your computer or mobile device, enter `https://<systemIPAddress>/control`.
The website displays with the system's room name and IP address.
2. Select **Connect**.
3. On your computer or mobile device, enter the four-digit code that displays on the system monitor.
Your computer or mobile device displays a user interface similar to the video system. You can then use your personal device to control the system.

Settings

Topics:

- [Video Adjustments](#)
- [Audio Adjustments](#)

Before or during calls, you can adjust video and audio settings, including adjusting the volume and changing the video layout.

Video Adjustments

You can manage video and certain user interface settings.

Change the Participant Layout

During a call, you can change from the current layout to another layout better suited for the meeting. The layout frames include the near site and far site.

If you're sharing content on a single monitor, content displays in one of the frames.

Procedure

1. In a call, go to **Menu** ≡ > **Layouts** .
2. Select one of the following layouts:
 - **Equal**: All participants are the same size.
 - **Gallery**: Participants display at the top of the screen and the speaker displays in the main frame.
 - **Fullscreen**: The active speaker displays in full screen.

Audio Adjustments



You can control several audio settings on the system.

Mute Your Microphones

To prevent distractions for the speaker and meeting participants, you can mute your microphones.

You can mute your audio in or out of a call.

Procedure



- » Do one of the following:
 - On your remote control, press **Mute** .
 - On the screen, select **Menu** ≡ > **Mute** .

A notification displays that the system muted your local microphones.

Unmute Your Microphones

When your audio is muted and you're ready to speak in a call, unmute your microphones.

Procedure

- » Do one of the following:
 - On your remote control, press **Mute** .
 - On the screen, select **Menu**  > **Unmute** .

Adjust the Volume

You can adjust the volume before or during a call.

Procedure

1. Go to **Menu**  > **Volume**.
2. Do one of the following:
 - Use the volume slider on a touchscreen.
 - Press the **+** or **-** buttons on the remote control.
 - Press the left or right navigation buttons on the remote control (when the system displays volume control).

Troubleshooting

Topics:

- [Poly Device Mode](#)
- [View Content Help Tips](#)
- [View Blackboard Help Tips](#)

This section includes information related to troubleshooting issues with your system. You can also find information on pairing your remote, configuring your monitors, and where to find help tips.

Poly Device Mode

Use these topics to troubleshoot problems you may encounter using Device Mode.

Audio Levels are Too High or Low

In Device Mode, audio from the video system speakers is too loud or it's difficult to hear call participants.

In Device Mode, your conferencing application and laptop control the video system's audio. You may need to adjust those volume controls.

Follow these steps until you get the audio levels you want:

Procedure

1. Adjust your conferencing application's volume.
2. Adjust your laptop's volume.

Conferencing Application Doesn't Use System Camera or Audio

Your conferencing application isn't using the video system's camera or audio in Device Mode.

Your conferencing application by default may choose the connected monitor speakers instead of, for example, the Studio X50 speakers.

Procedure

- » In your conferencing application, select the video system as your speaker, microphone, and camera device.

Can't Use System's Camera or Audio

Your conferencing application isn't using the video system's camera or audio in Device Mode. There could be a few reasons for these types of problems. For instance, your conferencing application by default may choose the connected monitor speakers instead of, for example, the Studio X50 speakers.

You may notice the following while using Device Mode:

- In your laptop's conferencing application, you can't select the video system as a camera or audio source.
- The video system's camera and audio seem unavailable.

- The video system's camera doesn't display live video.

Follow these steps until you fix your problem:

Procedure

1. In your conferencing application, select the video system as your speaker, microphone, and camera device.
2. In your laptop settings, select the video system as your speaker, microphone, and camera device.
3. Exit and restart Device Mode.
4. Replug the USB cable.
5. Connect the cable to a different USB port on your laptop.
6. Try using a different USB cable.
7. Restart your laptop.

Improve Audio Quality

Audio quality during calls in Device Mode could be better. For example, people on the call notice interference or dropped words when you're speaking.

You may encounter these problems for the following reasons: additional USB connections, a bad cable, or audio processing settings.

Follow these steps until your audio quality improves:

Procedure

1. Remove USB audio devices (such as a headset) connected to your laptop.
2. Connect your laptop and video system with a different USB cable.
3. If your conferencing application uses echo cancellation, disable that feature.
4. If you're playing a musical instrument, enable M-Mode in the system web interface.

Improve Laptop Screen Mirroring

When mirroring your laptop screen with an HDMI connection, the picture on the connected monitor isn't ideal.

The resolution on your laptop may need to be adjusted for the monitor connected to the Poly video system.

Follow these steps until screen mirroring quality improves:

Procedure

1. Adjust your laptop's resolution settings.
2. Adjust your laptop's display settings so the screen duplicates on the monitor.

Can't Share Wireless Content

You try sharing content wirelessly (for example, from an AirPlay-certified device) but nothing happens.

If your video system is in Poly Device Mode, you can't share content wirelessly. You must exit Device Mode to share wireless content to the video system.

Procedure



- » Do one of the following:
 - On the video system local interface or TC8 device (if you have one), select **Exit** .
 - Unplug the cables connecting your computer and video system. After two minutes, you see the video system home screen (even if you have not selected **Exit**).

View Content Help Tips

Content help tips provide information on how to stream content using HDMI, the Polycom Content App, or an Airplay- or a Miracast-certified device.

Note: If you're already connected to a source for sharing content, the help tips don't display.



Procedure

1. On the Home screen, select **Content** .
- The help screen opens.
2. Review the tips for your source type.
3. To go back to the previous screen, select **Back** .

View Blackboard Help Tips

For help annotating on your blackboard or whiteboard, you can access information on how to use the annotation icons and touch gestures.

Procedure

1. On the home screen, select **Blackboard** .
2. On the toolbar, select **Help** .
- The help screen opens.
3. To close the screen, tap the screen or press **Back**  on your remote control.