

Quick Tips for the Polycom® CX5100 Unified Conference Station for Microsoft® Skype™ for Business

3725-68837-002A | April 2016

About the CX5100 Unified Conference Station

The Polycom CX5100 Unified Conference Station lets you use the collaboration capabilities of Microsoft Lync and Skype for Business voice, video, and content while automatically tracking the flow of conversation to enable richer, more interactive communication.

The Polycom CX5100 System Features

The following figure shows the parts of the CX5100 system that includes the cameras, microphones, and speakers.

Polycom CX5100 system hardware features

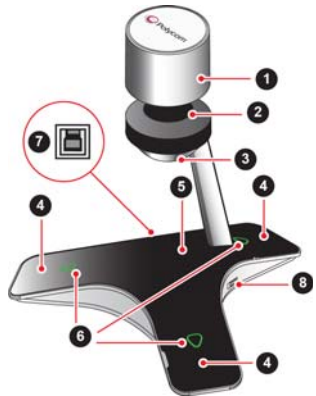

Polycom CX5100 System Features

Reference	Features
1	Camera Cover
2	Cameras

Polycom CX5100 System Features

Reference	Features
3	Active video indicator
4	Microphones
5	Speaker
6	Microphone mute buttons and status indicators
7	USB 3.0 Type B connection to computer
8	USB 2.0 connector for USB flash drive

The CX5100 System Indicator Lights

The indicator lights on the CX5100 system let you know when the system is sending audio or video in video calls, the microphones are muted, or the system is updating. See the following tables for information on the microphone and video indicator lights.

Microphone Indicator Lights

Indicator	Description
Off	Not in a call
Green	In a call
Flashing green	Ringing
Slow flashing green	System is starting up
Red	Microphone muted

Microphone Indicator Lights

Indicator	Description
Flashing red	Ringing with microphone muted, call on hold
Flashing green/red	Software update in progress

Active Video Indicator Lights

Indicator	Description
Off	Not in a call, no video in a call
Green	In an active video call
Flashing	Privacy cap is closed

Tips for Meeting Participants

Follow these best practices to ensure that your CX5100 system effectively tracks speakers and participants during conference calls.

- Make sure there are no items between your mouth and the microphones. For example, move your laptop so that it does not block you when you speak.
- Face the CX5100 system, not the whiteboard or the wall, when you stand at the front of a small conference room to speak. Facing the wall can cause echoes that interfere with the active speaker tracking.

- Avoid standing close to the conference table when speaking. Instead, sit at the table or move away from the table so the camera can clearly track your movements.

Connect the CX5100 System to Your Laptop

Before you begin placing video calls, you must connect the CX5100 system to your laptop to use the system.





To connect the CX5100 system to your laptop:

- » Plug the USB cable on the CX5100 to the USB 3.0 port on your laptop.

Place a Video Call

Using the Microsoft Lync or Skype for Business client on your computer and the CX5100 system, you can place video calls to contacts and systems in your organization.

To place a video call:

- 1 In the Microsoft Skype for Business client, do one of the following:
 - Click  and scroll to the contact you want to call.
 - Start typing a name in the search box and click . As you type, the system finds matching names.
 - Click  and choose a name from your Recent Calls.
- 2 Click a name to select it.
- 3 Click  to start a video call.

To invite others to join a conference:

- » From a conversation window in the Microsoft Skype for Business client, do one of the following:

- Click  and then click **Invite More People**. Find the person you want and click **OK**.
- Drag a contact from your contacts list into the conversation window.

Answer a Call

When you receive a call, you see a call notification that tells you who is calling.

To answer a call:

- » In the incoming call notification, do one of the following:
 - Click **Accept** to join the call.
 - Click **Redirect > Reply with an Instant Message** to send a message to the caller.

To refuse a call:

- » In the incoming call notification, do one of the following:
 - Click **Decline**.
 - Click **Ignore**.

End Calls

Hanging up a call with another person automatically disconnects the other person. When you hang up from a conversation that includes multiple participants, the other participants remain connected.

To end a call:

- » In the Microsoft Skype for Business client, click .

Control the Volume

During a call, you can control what you hear at the local site.

To adjust the volume:

- » Click  in your Windows tray and use the slider control.

Control Audio and Video

During a call, you can control what the far sites can hear and see.

To mute the microphone:

- » On the system, touch .

The microphone indicators on the system are red  when the system is muted.

You can also mute the system's audio using the Mute button in the Skype for Business client. However, muting the system in this way may not update the indicator lights on the tabletop unit.

To mute the video:

- » Lower the privacy cap on the tabletop unit. The active video indicator flashes green to indicate that the system is not sending video to the far end.

We are striving to improve the quality of our documentation, and we appreciate your feedback. Email your comments to DocumentationFeedback@polycom.com.